

## Below Ground Drainage, Water Supply, Utilities & Insulation



Trade Price List 2019 Rev 1

# Welcome to Polypipe

At Polypipe, conceiving, designing, manufacturing and delivering the most advanced products and systems isn't merely an occupation. It's a passion. One that's based around a few simple beliefs. Expertise isn't an option. Quality always beats quantity. Products are nothing without service and support. Sustainability isn't just a 'green' word. And working with our customers is much better than simply supplying them.

 **Leading Edge  
Design Expertise**

**SUPPORT**

**Application Based  
Technical Support** 

**Market  
Leadership**



**TRUST**



**Polypipe Brand**

**Breadth and Depth  
of Product Systems**



**RANGE**



**Substituting  
Legacy Materials**

**Manufacturing &  
Logistics Scale**



**CAPABILITY**



**Bespoke Product  
Solutions**



**Sustainable Products  
and Practices**

**SUSTAINABILITY**

**Enabling Sustainable  
Building Technology**



**Intelligent  
Engineered Solutions**

**VALUE**

**Smarter Thinking  
Better Solutions**



**Industry  
Authority**

**COMPETENCE**

**Product  
Innovation**

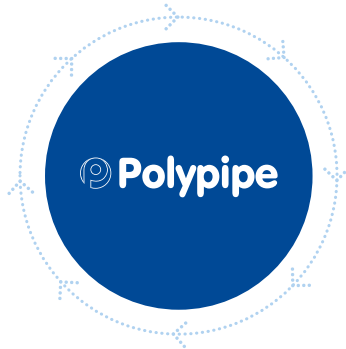

# Every job is covered

Polypipe offers a comprehensive range of below ground drainage products, incorporating all necessary systems for the disposal and redistribution of waste water and rainwater.

For further information on all above ground products, or for technical assistance, call **01709 770000**, visit our website [www.polypipe.com/building-products](http://www.polypipe.com/building-products) or contact your local Polypipe Area Manager.

<b>Drainage</b>	<b>4 - 39</b>
Underground Drain	4 - 9
Polycore and Polyrib Drainage	10 - 11
Access Fittings & Puddle Flanges	12
Anti-Splash Concrete Surrounds	13
Underground Drainage Adaptors	14 - 15
Settlement Fittings	16
Channel Components	17 - 18
Inspection Chambers, Covers and Frames	19 - 22
Inspection Chambers, Covers and Frames Polypropylene	22
SFA7 Inspection Chambers, Covers and Frames Polypropylene	23 - 24
SFA7 Pipe Riser Inspection Chambers, Covers and Frames	25
IC600 Pipe Riser Inspection Chambers, Covers and Frames	26
Polysewer Gravity Sewer System	27 - 30
Sewerdrain Gravity Sewer System	31 - 33
Flexicon - Flexible Rubber Couplers and Adaptors	34 - 37
Flexicon Reducing Bushes	38
Underground Ancillaries	39

<b>Water Supply</b>	<b>40 - 52</b>
Water Service Pipes MDPE PE80	40
Polyfast Polyethylene Compression Fittings	41 - 49
Polyguard Barrier Pipe & Fittings	50 - 51
Water Supply Pipe and Fittings Ancillaries	52

<b>Utilities</b>	<b>53</b>
Gas Pipe	53

<b>Geothermal Systems</b>	<b>54</b>
---------------------------	-----------

<b>Pre-Insulated Pipes</b>	<b>55</b>
----------------------------	-----------

<b>Civils</b>	<b>55 - 69</b>
Polystorm Modular Water Storage	56 - 58
Rainstream Home & Garden	59 - 62
General Purpose Duct System	63
Land Drainage Pipes and Couplers	64
Ridgidrain	65 - 66
Ridgiduct, Ridgicoil & Polyduct	67
Gullys	68
Channel Drainage	69

<b>Miscellaneous</b>	<b>70</b>
----------------------	-----------

<b>Insulation</b>	<b>71 - 78</b>
Cavity Closer - Open Cavity	71 - 74
Cavity Closer - Closed Cavity	75
Cavity Closer - Party Wall	76
Acoustic Cavity Sock	77
Loft Hatch	78

<b>General Information</b>	<b>79 - 84</b>
Spares & Ancillaries	79
Index	79 - 85
Guide to Order Procedures	86
General Trading Information	87
Terms & Conditions	88 - 91

# Drainage

## Underground Drain - PVCu

Terracotta brown unless otherwise stated

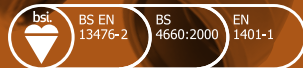

KM583143 KM59284 KM06383

Polypipe

Plain Ended Pipe	Code	Pack Qty.	Bulk Qty.	Product Group	Price Each £
3in/82mm. 3m length.	UG330	1	104	50E	52.52
3in/82mm. 6m length.	UG360	1	104	50E	104.82
4in/110mm. 3m length.	UG430	1	57	50E	35.45
4in/110mm. 6m length.	UG460	1	57	50E	70.65
6in/160mm. 3m length.	UG630	1	46	50E	99.90
6in/160mm. 6m length.	UG660	1	46	50E	171.90

Single Socket Pipe	Code	Pack Qty.	Bulk Qty.	Product Group	Price Each £
4in/110mm. 3m length.	UG432	1	57	50E	45.65
4in/110mm. 6m length.	UG462	1	57	50E	78.70
6in/160mm. 3m length.	UG632	1	46	50E	120.81
6in/160mm. 6m length.	UG662	1	46	50E	198.86

Plain Ended Perforated Pipe	Code	Pack Qty.	Bulk Qty.	Product Group	Price Each £
4in/110mm. 6m length.	UG465	1	57	50E	132.42
6in/160mm. 6m length.	UG665	1	46	50E	249.52

Single Socket Perforated Pipe	Code	Pack Qty.	Bulk Qty.	Product Group	Price Each £
4in/110mm. 6m length.	UG469	1	57	50E	141.79
6in/160mm. 6m length.	UG669	1	46	50E	279.20

Manhole Connector	Code	Pack Qty.	Bulk Qty.	Product Group	Price Each £
6in/160mm. 600mm (Sand Coated one end).	UGR699	1	46	50E	23.44

Temporary Pipe Cap	Code	Pack Qty.	Bulk Qty.	Product Group	Price Each £
4in/110mm. For Site protection of Plain End Pipe.	PC04	1	100	51M	3.66

Single Socket Coupler	Code	Pack Qty.	Bulk Qty.	Product Group	Price Each £
3in/82mm. Requires Solvent Welding.	USH33	1	20	51M	12.72
4in/110mm. Requires Solvent Welding.	USH43	1	10	51M	13.94
6in/160mm. Requires Solvent Welding.	USH643	1	20	51M	30.03

# Drainage

## Underground Drain - PVCu

Terracotta brown unless otherwise stated







KM59284 KM06383

Polypipe

Double Socket Coupler	Code	Pack Qty.	Bulk Qty.	Product Group	Price Each £	
3in/82mm. Remove Centre Stop for use as Slip Coupling.	UG301	1	20	51M	13.40	
4in/110mm. Slip Coupler - No Centre Stop	UG400	10	10	51M	11.20	
4in/110mm. With Centre Stop	UG401	10	10	51M	11.21	
6in/160mm. Remove Centre Stop for use as Slip Coupling.	UG601	1	10	51M	26.49	

Polypropylene Double Socket Coupler	Code	Pack Qty.	Bulk Qty.	Product Group	Price Each £	
4in/110mm. Do Not Solvent Weld.	<b>NEW</b> UG402	10	10	51M	8.75	
6in/160mm. Do Not Solvent Weld.	UG602	1	10	51M	21.06	

Single Socket Bend	Code	Pack Qty.	Bulk Qty.	Product Group	Price Each £	 UG468  UG410  UG408
3in/82mm. 87½°.	UG312	1	10	51M	23.37	
4in/110mm. 87½°.	UG489	1	10	51M	18.80	
6in/160mm. 87½°.	UG612	1	5	51M	67.61	
3in/82mm. 45°.	UG304	1	20	51M	23.37	
4in/110mm. 45°.	UG404	10	10	51M	18.82	
6in/160mm. 45°.	UG604	1	10	51M	67.61	
4in/110mm. 30°.	UG468	10	10	51M	19.60	
6in/160mm. 30°.	UG668	1	10	51M	70.22	
4in/110mm. 15°.	UG410	10	10	51M	19.60	
6in/160mm. 15°.	UG610	1	10	51M	70.22	
4in/110mm. 11¼°.	UG408	1	10	51M	21.60	

Double Socket Bend	Code	Pack Qty.	Bulk Qty.	Product Group	Price Each £	 UG484  UG409
4in/110mm. 87½°.	UG484	1	10	51M	23.75	
6in/160mm. 87½°.	UG611	1	5	51M	78.98	
4in/110mm. 45°.	UG403	1	10	51M	23.80	
6in/160mm. 45°.	UG603	1	10	51M	78.98	
4in/110mm. 30°.	UG467	1	10	51M	22.62	
6in/160mm. 30°.	UG667	1	10	51M	82.31	
4in/110mm. 15°.	UG409	1	10	51M	23.55	
6in/160mm. 15°.	UG609	1	10	51M	82.31	
4in/110mm. 11¼°.	UG407	1	10	51M	25.90	

# Drainage

## Underground Drain - PVCu

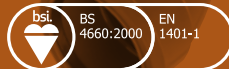

Terracotta brown unless otherwise stated





KM59284 KM06383

Polypipe

87½° Long Radius Bends	Code	Pack Qty.	Bulk Qty.	Product Group	Price Each £	 UG412
4in/110mm. 87½° Long Radius - Single Socket.	UG412	1	10	51M	19.82	
4in/110mm. 87½° Long Radius - Double Socket.	UG411	10	10	51M	25.10	
4in/110mm. 87½° Long Radius - Double Socket Rest Bend.	UG483	1	10	51M	28.51	

Adjustable Bend Double Socket	Code	Pack Qty.	Bulk Qty.	Product Group	Price Each £	
4in/110mm 30°. PP Do Not Solvent Weld	UG494	1	10	51M	30.70	
4in/110mm 90°. PP Do Not Solvent Weld 	UG479	1	10	51M	39.18	

Long Radius Bend	Code	Pack Qty.	Bulk Qty.	Product Group	Price Each £	 UG471
4in/110mm. 87½° Plain Ended.	UG471	1	7	51M	76.89	
6in/160mm. 87½° Plain Ended.	UG671	1	1	51M	139.02	
4in/110mm. 45° Plain Ended.	UG472	1	10	51M	67.61	
6in/160mm. 45° Plain Ended.	UG672	1	10	51M	102.12	
4in/110mm. 22½° Plain Ended.	UG473	1	10	51M	56.52	
4in/110mm. 11¼° Plain Ended.	UG474	1	10	51M	56.78	

Equal Junctions	Code	Pack Qty.	Bulk Qty.	Product Group	Price Each £	 UG406
3in/82mm. 87½° Double Socket.	UG324	1	10	51M	41.37	
4in/110mm. 87½° Double Socket.	UG424	1	10	51M	34.51	
6in/160mm. 87½° Double Socket.	UG624	1	5	51M	136.53	
4in/110mm. 45° Double Socket.	UG406	1	10	51M	34.51	
6in/160mm. 45° Double Socket.	UG606	1	5	51M	136.53	
4in/110mm. 87½° Triple Socket.	UG423	1	10	51M	41.65	
6in/160mm. 87½° Triple Socket.	UG623	1	5	51M	146.27	
4in/110mm. 45° Triple Socket.	UG405	1	10	51M	41.65	
6in/160mm. 45° Triple Socket.	UG605	1	5	51M	146.27	

Unequal Junctions	Code	Pack Qty.	Bulk Qty.	Product Group	Price Each £	 UG644
6in/160mm. 87½° Double Socket (160 x 160 x 110mm).	UG644	1	5	51M	115.37	
6in/160mm. 45° Double Socket (160 x 160 x 110mm).	UG636	1	5	51M	115.37	
6in/160mm. 87½° Triple Socket (160 x 160 x 110mm).	UG643	1	5	51M	126.85	
6in/160mm. 45° Triple Socket (160 x 160 x 110mm).	UG635	1	5	51M	126.85	

# Drainage

## Underground Drain - PVCu

Terracotta brown unless otherwise stated

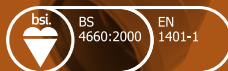





KM59284 KM06383

Polypipe

Level Invert Reducer	Code	Pack Qty.	Bulk Qty.	Product Group	Price Each £	
4in/110mm. 110mm Spigot x 82mm Socket.	UG421	1	20	51M	23.19	UG421
6in/160mm. 160mm Spigot x 110mm Socket.	UG621	1	10	51M	46.35	

Plain Socket Plug	Code	Pack Qty.	Bulk Qty.	Product Group	Price Each £	
3in/82mm. Also for site protection of socket.	UG320	1	10	51M	13.21	
4in/110mm. Also for site protection of socket.	UG420	1	10	51M	13.80	
6in/160mm. Also for site protection of socket.	UG620	1	10	51M	28.02	

Bottle Gully	Code	Pack Qty.	Bulk Qty.	Product Group	Price Each £	
4in/110mm. Plain (Roddable) inc. round PP grid (Black).	UG425	1	5	51M	62.52	

Back Inlet Bottle Gully	Code	Pack Qty.	Bulk Qty.	Product Group	Price Each £	
4in/110mm. Roddable inc. round PP grid (Black) (Open 110mm rear inlet).	UG427	1	5	51M	79.49	

Back Inlet Bottle Gully Square Top	Code	Pack Qty.	Bulk Qty.	Product Group	Price Each £	
4in/110mm. Removable dip tube provides 50mm deep trap. Roddable inc. black PP screwed grid, capped 110mm rear inlet and 2 bosses (cut ends off rubber blanking caps to adapt to 40mm waste pipe)	UG446	1	1	51M	99.25	

Bottle Gully Ancillaries	Code	Pack Qty.	Bulk Qty.	Product Group	Price Each £	
4in/110mm. Round Aluminium Grid.	UG442	1	50	51M	19.55	UG426
4in/110mm. Spare PP Round Grid.	UG426	1	100	51M	7.25	
4in/110mm. Sealed Access Cover (Aluminium).	UG433	1	10	51M	101.70	UG427S
4in/110mm. Blanking Plug with Boss Shoulder for waste connection.	UG427S	1	25	51M	17.08	
4in/110mm. Back Entry Bend.	UG480	1	10	51M	20.39	
4in/110mm. Raising Piece marked for cutting to required height max 225mm.	UG427R	1	10	51M	18.09	UG480
4in/110mm. Square Top surround - Black PP 228mm x 228mm (not for UG433).	UG418	1	20	51M	12.75	

Anti-Flood Valve	Code	Pack Qty.	Bulk Qty.	Product Group	Price Each £	
4in/110mm. Spigot/Socket.	AFV110	1	1	51M	304.26	
6in/160mm. Spigot/Socket.	AFV160	1	1	51M	374.96	

Prices shown are for one item excluding VAT

# Drainage

## Underground Drain - PVCu

Terracotta brown unless otherwise stated



KM59284 KM06383

Polypipe

Lowback 'P' Trap (Spigot Outlet/ Socket Inlet)	Code	Pack Qty.	Bulk Qty.	Product Group	Price Each £	
4in/110mm. To convert to 'S' Trap add 87½° Bend. To convert to 'Q' Trap add 45° Bend. Invert depth not to exceed 600mm when used below Hoppers. Drop Rod hole is for suspended system.	UG498	1	10	51M	51.58	
Universal Gully Trap	Code	Pack Qty.	Bulk Qty.	Product Group	Price Each £	
4in/110mm. Socket/Spigot 45°.	UG413	1	10	51M	29.83	
Back Inlet Square Hopper	Code	Pack Qty.	Bulk Qty.	Product Group	Price Each £	
4in/110mm. Spigot Outlet inc square PP Grid (Black) use with UG413.	UG414B	1	20	51M	31.12	
Square Hopper - Socket	Code	Pack Qty.	Bulk Qty.	Product Group	Price Each £	
4in/110mm. Solvent Socket inc. Square PP grid (Black).	UG414	1	30	51M	23.19	
Raising Piece for UG414/UG414B	Code	Pack Qty.	Bulk Qty.	Product Group	Price Each £	
4in/110mm. 160mm depth.	UG470	1	10	51M	14.44	
Square Aluminium Grid for UG414/UG414B	Code	Pack Qty.	Bulk Qty.	Product Group	Price Each £	
4in/110mm. 150mm x 150mm.	UG443	1	50	51M	15.55	
Spare Square PP Grid (Black) for UG414/UG414B	Code	Pack Qty.	Bulk Qty.	Product Group	Price Each £	
4in/110mm. 150mm x 150mm.	UG415	1	100	51M	7.25	
Rectangular Hopper	Code	Pack Qty.	Bulk Qty.	Product Group	Price Each £	
4in/110mm. 140mm Spigot inc rectangular PP grid (Black). 275mm x 175mm.	UG428	1	5	51M	30.85	
Spare Rectangular PP grid (Black)	Code	Pack Qty.	Bulk Qty.	Product Group	Price Each £	
4in/110mm. 250mm x 150mm for UG428.	UG429	1	10	51M	7.61	



# Drainage

## Underground Drain - PVCu

Terracotta brown unless otherwise stated



KM59284 KM06383

Polypipe

<b>Square Hopper - Spigot</b>	<b>Code</b>	<b>Pack Qty.</b>	<b>Bulk Qty.</b>	<b>Product Group</b>	<b>Price Each £</b>	
4in/110mm. Spigot Tail (104mm) inc Square PP grid.(Black)	UG417	1	10	51M	29.41	
<b>Spare Square PP Grid (Black) for UG417</b>	<b>Code</b>	<b>Pack Qty.</b>	<b>Bulk Qty.</b>	<b>Product Group</b>	<b>Price Each £</b>	
4in/110mm. 155mm x 155mm.	UG4176	1	100	51M	7.25	
<b>Square Sealed Cover for UG417</b>	<b>Code</b>	<b>Pack Qty.</b>	<b>Bulk Qty.</b>	<b>Product Group</b>	<b>Price Each £</b>	
4in/110mm. 155mm x 155mm. Converts UG417 Square Hopper from Open Grid to Sealed Cover	UG4175	1	100	51M	8.26	
<b>Waste Inlet Adaptor</b>	<b>Code</b>	<b>Pack Qty.</b>	<b>Bulk Qty.</b>	<b>Product Group</b>	<b>Price Each £</b>	
For 40mm Pipe. Cut off base and use in the UG417 Boss Connection. Also fits UG446.	UG4177	1	10	51M	5.57	

# Drainage

## Polycore and Polyrib Drainage - PVCu

Terracotta brown unless otherwise stated



Polypipe

Polycore Plain Ended Pipe	Code	Pack Qty.	Bulk Qty.	Product Group	Price Each £
4in/110mm. 3m length.	UFC430	1	57	103E	31.77
4in/110mm. 6m length.	UFC460	1	57	103E	63.31
6in/160mm. 3m length.	UFC630	1	46	103E	85.32
6in/160mm. 6m length.	UFC660	1	46	103E	154.05



Polycore Single Socket Pipe	Code	Pack Qty.	Bulk Qty.	Product Group	Price Each £
4in/110mm. 3m length.	UFC432	1	57	103E	40.88
4in/110mm. 6m length.	UFC462	1	57	103E	70.53
6in/160mm. 3m length.	UFC632	1	46	103E	103.15
6in/160mm. 6m length.	UFC662	1	46	103E	178.23



Couplers	Code	Pack Qty.	Bulk Qty.	Product Group	Price Each £
4in/110mm. Double Socket Coupler (Remove Centre Stop for use as slip coupler).	UR401	1	10	59M	10.15
6in/160mm. Double Socket Coupler (Remove Centre Stop for use as slip coupler).	UG601	1	10	51M	26.49



Reducer	Code	Pack Qty.	Bulk Qty.	Product Group	Price Each £
6in/160mm. 160mm Spigot x 110mm Socket.	UG621	1	10	51M	46.35



87½° Single Socket Bend	Code	Pack Qty.	Bulk Qty.	Product Group	Price Each £
4in/110mm. Socket/Spigot Short Radius Swept Bend.	UR412	1	10	59M	17.05
6in/160mm. Socket/Spigot Short Radius Swept Bend.	UR612	1	5	59M	61.30



45° Single Socket Bend	Code	Pack Qty.	Bulk Qty.	Product Group	Price Each £
4in/110mm. Socket/Spigot.	UR404	1	10	59M	17.05
6in/160mm. Socket/Spigot.	UR604	1	10	59M	61.30



30° Single Socket Bend	Code	Pack Qty.	Bulk Qty.	Product Group	Price Each £
4in/110mm. Socket/Spigot.	UR468	1	10	59M	17.75
6in/160mm. Socket/Spigot.	UR668	1	10	59M	60.36



15° Single Socket Bend	Code	Pack Qty.	Bulk Qty.	Product Group	Price Each £
4in/110mm. Socket/Spigot.	UR410	1	10	59M	17.75
6in/160mm. Socket/Spigot.	UR610	1	10	59M	60.36



# Drainage

## Polycore and Polyrib Drainage - PVCu

Terracotta brown unless otherwise stated



87½° Double Socket Bend	Code	Pack Qty.	Bulk Qty.	Product Group	Price Each £	
4in/110mm. Socket/Socket Short Radius Swept Bend.	UR411	1	10	59M	21.58	
6in/160mm. Socket/Socket Short Radius Swept Bend.	UR611	1	5	59M	71.61	
45° Double Socket Bend	Code	Pack Qty.	Bulk Qty.	Product Group	Price Each £	
4in/110mm. Socket/Socket.	UR403	1	10	59M	21.58	
6in/160mm. Socket/Socket.	UR603	1	10	59M	71.61	
30° Double Socket Bend	Code	Pack Qty.	Bulk Qty.	Product Group	Price Each £	
4in/110mm. Socket/Socket.	UR467	1	10	59M	20.51	
6in/160mm. Socket/Socket.	UR667	1	10	59M	70.73	
15° Double Socket Bend	Code	Pack Qty.	Bulk Qty.	Product Group	Price Each £	
4in/110mm. Socket/Socket.	UR409	1	10	59M	21.30	
6in/160mm. Socket/Socket.	UR609	1	10	59M	70.73	
Equal Junctions	Code	Pack Qty.	Bulk Qty.	Product Group	Price Each £	 UG424
4in/110mm. 87½° Double Socket/Spigot.	UR424	1	10	59M	31.44	
4in/110mm. 45° Double Socket/Spigot.	UR406	1	10	59M	31.44	
6in/160mm. 45° Double Socket/Spigot.	UR606	1	5	59M	124.35	
4in/110mm. 87½° Triple Socket .	UR423	1	10	59M	40.47	
4in/110mm. 45° Triple Socket.	UR405	1	10	59M	37.77	
6in/160mm. 45° Triple Socket.	UR605	1	5	59M	125.71	
Unequal Junction	Code	Pack Qty.	Bulk Qty.	Product Group	Price Each £	
6in/160mm. 45° Double Socket/Spigot (160 x 160 x 110mm).	UR636	1	5	59M	99.65	
6in/160mm. 45° Triple Socket (160 x 160 x 110mm).	UR635	1	5	59M	109.55	

# Drainage

## Access Fittings & Puddle Flanges - PVCu

Terracotta brown unless otherwise stated



KM59284

Polypipe

45° Rodding Eye Terminal	Code	Pack Qty.	Bulk Qty.	Product Group	Price Each £	
4in/110mm. Aluminium Plain Oval Top/Spigot Tail (c/w Plate and Screws).	UG422	1	20	51M	80.65	 UG522
4in/110mm. Sealed Oval Top/Spigot Tail.	UG422S	1	20	51M	87.29	
6in/160mm. Sealed Oval Top/Socket Tail.	UG622S	1	8	51M	200.12	
4in/110mm. Aluminium Sealed Square Top/Socket Tail.	UG416S	1	15	51M	94.87	 UG521
4in/110mm. Black PP Sealed Square Top/Spigot Tail. Tail angled 45° (Do not Solvent Weld).	UG522	1	10	51M	67.46	
4in/110mm. Black PP Sealed Square Top/Socket Tail. Tail angled 45° (Do not Solvent Weld).	UG521	1	10	51M	75.01	 UG523
4in/110mm. Black PP Sealed Square Top/Socket Tail. Straight 90° (Do not Solvent Weld).	<b>NEW</b> UG523	1	10	51M	75.01	

Access Pipe	Code	Pack Qty.	Bulk Qty.	Product Group	Price Each £	
4in/110mm. Single Socket with 3 Boss Shoulders.	USA43	1	10	51M	53.30	
6in/160mm. Single Socket - Plain only.	USA643	1	10	51M	117.22	

Screwed Access Plug and Cap	Code	Pack Qty.	Bulk Qty.	Product Group	Price Each £	
4in/110mm. Spigot Tail. Plug.	USA62	1	20	51M	24.19	 USA62
6in/160mm. Spigot Tail. Plug.	USA662	1	10	51M	54.51	
4in/110mm. Solvent Socket Tail. Cap.	USA63	1	20	51M	25.95	

Access Bend	Code	Pack Qty.	Bulk Qty.	Product Group	Price Each £	
4in/110mm. 92½° Single Socket.	USB413	1	10	51M	75.01	

Puddle Flange	Code	Pack Qty.	Bulk Qty.	Product Group	Price Each £	
4in/110mm. Ring seal socket/Solvent socket 200 x 200mm Grey PVC Flange.	PUD110	1	25	51M	52.52	
6in/160mm. Ring seal socket/Solvent socket 240mm x 240mm Grey PVC Flange.	PUD160	1	10	51M	86.37	

# Drainage

## Anti-Splash Concrete Surrounds

Supplied factory bonded to PVCu gullies and hoppers as a complete unit ready to install on site



KM59284



Bottle Gully (with Anti-Splash Top)	Code	Pack Qty.	Bulk Qty.	Product Group	Price Each £	
4in/110mm. Plain (inc. Round Black PP grid).	UG425AST	1	1	51M	112.94	
4in/110mm. Back Inlet (inc. Round Black PP grid).	UG427AST	1	1	51M	117.60	
Bottle Gully Raising Piece (with Anti-Splash Top)	Code	Pack Qty.	Bulk Qty.	Product Group	Price Each £	
4in/110mm. Raising piece marked for cutting to required height (max 225mm).	UG427RAST	1	1	51M	49.46	
Square Hopper (with Anti-Splash Top)	Code	Pack Qty.	Bulk Qty.	Product Group	Price Each £	
4in/110mm. Solvent/Socket Outlet (inc. Square Black PP grid)	UG414AST	1	1	51M	54.67	
Rectangular Hopper (with Anti-Splash Top)	Code	Pack Qty.	Bulk Qty.	Product Group	Price Each £	
4in/110mm. 140mm Spigot End (inc. Rectangular Black PP grid).	UG428AST	1	1	51M	62.10	
Aluminium Square Flush to Top Grids	Code	Pack Qty.	Bulk Qty.	Product Group	Price Each £	
4in/110mm. Light Duty 207mm x 207mm. For use with square anti-splash tops.	UG454	1	25	51M	29.82	
4in/110mm. Heavy Duty 207mm x 207mm. For use with square anti-splash tops.	UG543	1	10	51M	84.66	

## New Back Inlet Gully



New UG446 back inlet bottle gully with square top for discharge of external rainwater or waste pipes to drains is now available, complete with two low level waste inlets for 40mm pipe.

**See page 7 for more details!**



# Drainage

## Underground Drainage Adaptors

Terracotta brown unless otherwise stated





KM59284





Clay/Cast Iron Adaptors	Code	Pack Qty.	Bulk Qty.	Product Group	Price Each £	 UG463
4in/110mm. To Spigot.	UG463	1	10	51M	28.32	
6in/160mm. To Spigot.	UG663	1	4	51M	61.10	
4in/110mm. To Socket.	UG464	1	10	51M	21.79	
6in/160mm. To Socket.	UG664	1	4	51M	45.51	

SuperSleeve Pipe Adaptors (Polypropylene)	Code	Pack Qty.	Bulk Qty.	Product Group	Price Each £	 UG459
4in/110mm. SuperSleeve Socket to PVC Spigot.	UG459	1	30	51M	22.62	
6in/160mm. SuperSleeve Socket to PVC Spigot.	UG659	1	20	51M	33.81	
4in/110mm. SuperSleeve Socket to PVC Socket.	UG434	1	30	51M	26.32	
6in/160mm. SuperSleeve Socket to PVC Socket.	UG634	1	20	51M	39.61	

Thick Clay Pipe Adaptors (Polypropylene)	Code	Pack Qty.	Bulk Qty.	Product Group	Price Each £	 UG487
4in/110mm. Thick Clay Socket to PVC Spigot.	UG487	1	30	51M	24.19	
6in/160mm. Thick Clay Socket to PVC Spigot.	UG697	1	20	51M	35.79	
4in/110mm. Thick Clay Socket to PVC Socket.	UG486	1	30	51M	28.02	
6in/160mm. Thick Clay Socket to PVC Socket.	UG696	1	20	51M	41.57	

Ultrarib Adaptor	Code	Pack Qty.	Bulk Qty.	Product Group	Price Each £	
150mm. Ultrarib Socket to EN1401 Spigot.	UG6106	1	1	51M	74.36	

Universal Drain Adaptors (Black EPDM)	Code	Pack Qty.	Bulk Qty.	Product Group	Price Each £	
4in/110mm. Locates on Spigot - Flexible to accept all Waste and Rainwater pipes inc. Square.	UG493	1	250	51M	9.75	
4in/110mm. Locates on Socket - Flexible to accept all Waste and Rainwater pipes inc. Square.	UG485	1	250	51M	9.75	

Rainwater	Code	Pack Qty.	Bulk Qty.	Product Group	Price Each £	
4in/110mm. Spigot/Socket to 68mm Round Socket (Do not Solvent Weld Polypropylene).	UG254	1	50	51M	9.07	
3in/82mm. Spigot/Socket to 68mm Round Socket (PP Do not Solvent Weld Polypropylene).	UG253	1	50	51M	7.94	

# Drainage



## Underground Drainage Adaptors

Terracotta brown unless otherwise stated



KM59284

 Polypipe

Waste Pipe Adaptors	Code	Pack Qty.	Bulk Qty.	Product Group	Price Each £	
4in/110mm. Socket to 32mm single.	UG455	1	25	51M	18.09	
4in/110mm. Socket to 40mm single.	UG456	1	25	51M	18.09	
4in/110mm. Socket to 50mm single.	UG457	1	25	51M	20.57	
4in/110mm. 32mm and 40mm double mixed to Socket.	UG461	1	25	51M	23.81	
4in/110mm. 40mm and 40mm double equal to Socket.	UG492	1	25	51M	23.81	
4in/110mm. Single to Pipe or Spigot (Requires Waste Boss Adaptor).	UG435	1	25	51M	12.00	

UG457







UG492

# Drainage

## Settlement Fittings

For situations where differential settlement may be an issue.  
Terracotta Brown unless otherwise stated



<b>Settlement Socket</b> 300mm overall length	<b>Code</b>	<b>Pack Qty.</b>	<b>Bulk Qty.</b>	<b>Product Group</b>	<b>Price Each £</b>	
4in/110mm. Allows for up to 150mm movement. Overall length 300mm.	SS700	1	1	51M	33.89	
<b>Settlement Socket</b> 390mm overall length	<b>Code</b>	<b>Pack Qty.</b>	<b>Bulk Qty.</b>	<b>Product Group</b>	<b>Price Each £</b>	
4in/110mm. Allows for up to 250mm movement. Overall length 390mm.	SS701	1	1	51M	57.17	
<b>Settlement Branch Pipe (92½° to Soil)</b>	<b>Code</b>	<b>Pack Qty.</b>	<b>Bulk Qty.</b>	<b>Product Group</b>	<b>Price Each £</b>	
4in/110mm. 210mm Spigot tail for use with SS704 or 706.	SS702	1	1	51M	55.15	
<b>Solvent Branch only (92½° to Soil)</b>	<b>Code</b>	<b>Pack Qty.</b>	<b>Bulk Qty.</b>	<b>Product Group</b>	<b>Price Each £</b>	
4in/110mm. Solvent weld required pipe length into bottom socket on site. Solvent Socket.	SS703	1	1	51M	42.91	
<b>Settlement 92½° Rest Bend</b>	<b>Code</b>	<b>Pack Qty.</b>	<b>Bulk Qty.</b>	<b>Product Group</b>	<b>Price Each £</b>	
4in/110mm. Max 150mm movement - for use at foot of soil stack.	SS704	1	1	51M	78.18	
<b>Solvent 92½° Rest Bend only</b>	<b>Code</b>	<b>Pack Qty.</b>	<b>Bulk Qty.</b>	<b>Product Group</b>	<b>Price Each £</b>	
4in/110mm. Solvent weld SS700, or SS701 on site. Solvent Socket.	SS705	1	1	51M	42.43	
<b>Settlement 92½° Stub Bend</b>	<b>Code</b>	<b>Pack Qty.</b>	<b>Bulk Qty.</b>	<b>Product Group</b>	<b>Price Each £</b>	
4in/110mm. Max 150mm movement - NOT to be used at foot of soil stack.	SS706	1	1	51M	75.02	
<b>Solvent 92½° Stub Bend only</b>	<b>Code</b>	<b>Pack Qty.</b>	<b>Bulk Qty.</b>	<b>Product Group</b>	<b>Price Each £</b>	
4in/110mm. Solvent Weld SS700, or SS701 on site. Solvent Socket.	SS707	1	1	51M	39.54	

Settlement fittings are made to order, allow 14 days



# Drainage

## Channel Components - PVCu

Terracotta brown unless otherwise stated



KM59284

Polypipe

Channel Access Pipe	Code	Pack Qty.	Bulk Qty.	Product Group	Price Each £	
4in/110mm. 1.5m Double Spigot.	UG447	1	1	51M	79.35	
6in/160mm. 1.5m Double Spigot.	UG647	1	1	51M	122.38	

Manhole Connectors	Code	Pack Qty.	Bulk Qty.	Product Group	Price Each £	
4in/110mm. 0.6m Double Spigot.	UG448	1	1	51M	46.33	
6in/160mm. 0.6m Double Spigot.	UG648	1	1	51M	59.94	

Channel Coupling	Code	Pack Qty.	Bulk Qty.	Product Group	Price Each £	
4in/110mm. Socket/Socket.	UG449	1	1	51M	12.41	
6in/160mm. Socket/Socket.	UG649	1	1	51M	22.03	

Channel Bends	Code	Pack Qty.	Bulk Qty.	Product Group	Price Each £	
4in/110mm. 87½° Single Socket Left Hand.	UG450L	1	1	51M	21.16	
4in/110mm. 87½° Single Socket Right Hand.	UG450R	1	1	51M	21.16	
6in/160mm. 87½° Single Socket Left Hand.	UG650L	1	1	51M	44.85	
6in/160mm. 87½° Single Socket Right Hand.	UG650R	1	1	51M	44.85	UG451R
4in/110mm. 45° Single Socket Left Hand.	UG451L	1	1	51M	21.16	
4in/110mm. 45° Single Socket Right Hand.	UG451R	1	1	51M	21.16	
6in/160mm. 45° Single Socket Left Hand.	UG651L	1	1	51M	44.85	
6in/160mm. 45° Single Socket Right Hand.	UG651R	1	1	51M	44.85	UG451L
4in/110mm. 87½° Double Socket.	UG475	1	1	51M	24.49	
4in/110mm. 45° Double Socket.	UG476	1	1	51M	24.49	

Three Quarter Channel Bends (with full socket inlet)	Code	Pack Qty.	Bulk Qty.	Product Group	Price Each £	
4in/110mm. 87½° Left Hand.	UG948L	1	1	51M	32.85	
4in/110mm. 87½° Right Hand.	UG947R	1	1	51M	32.85	
4in/110mm. 45° Left Hand.	UG946L	1	1	51M	32.85	
4in/110mm. 45° Right Hand.	UG945R	1	1	51M	32.85	UG946L

# Drainage

## Channel Components - PVCu

Terracotta brown unless otherwise stated



Polypipe

Equal Channel Junctions	Code	Pack Qty.	Bulk Qty.	Product Group	Price Each £	
4in/110mm. 87½° Double Socket Left Hand.	UG452L	1	1	51M	36.79	<p>UG452L</p> <p>UG452R</p>
4in/110mm. 87½° Double Socket Right Hand.	UG452R	1	1	51M	36.79	
4in/110mm. 45° Double Socket Left Hand.	UG453L	1	1	51M	36.79	
4in/110mm. 45° Double Socket Right Hand.	UG453R	1	1	51M	36.79	
4in/110mm. 87½° Triple Socket Left Hand.	UG477L	1	1	51M	42.73	
4in/110mm. 87½° Triple Socket Right Hand.	UG477R	1	1	51M	42.73	
4in/110mm. 45° Triple Socket Left Hand.	UG478L	1	1	51M	42.73	
4in/110mm. 45° Triple Socket Right Hand.	UG478R	1	1	51M	42.73	
Unequal Channel Junctions (160 x 160 x 110mm)	Code	Pack Qty.	Bulk Qty.	Product Group	Price Each £	
6in/160mm. 45° Double Socket Left Hand.	UG654L	1	1	51M	69.18	
6in/160mm. 45° Double Socket Right Hand.	UG654R	1	1	51M	69.18	
Long Radius Channel Bends (Plain Ended)	Code	Pack Qty.	Bulk Qty.	Product Group	Price Each £	
4in/110mm. 87½°.	UG481	1	1	51M	97.96	<p>UG481</p>
6in/160mm. 87½°.	UG681	1	1	51M	149.04	
4in/110mm. 45°.	UG482	1	1	51M	83.89	
6in/160mm. 45°.	UG682	1	1	51M	128.15	

## New 320mm Side Riser UG466



- **Robust finned seal**
- **Watertight for first time site testing**
- **No additional seals or sealant required for installation**



# Drainage

## Inspection Chambers, Covers and Frames

Polypropylene Black unless otherwise stated.



### Loading Classification for Cover and Frames

A = Equivalent to Class A15 load category of BS EN 124-1 2015

(Pedestrians & pedal cyclists only)











A+ = Tested to withstand 35kN test load (Light vehicular traffic on domestic drives)

C = Tested to withstand 10kN test load (non-vehicular traffic only)

B125 = Class B125 load category of BS EN 124-1 2015 (Driveways, Footways & Landscaped Areas)

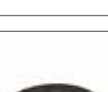
**Riser Joints:** We recommend a UG388 sealing ring should be used on the UG438. Alternatively sealant conforming to BS EN ISO 11600 can be used for jointing the riser sections. To ensure an adequate seal it is imperative that the gap between the two fins on the UG438 riser is filled excessively with sealant and any excess, following location, should be smoothed around the joints.

The UG466 riser is supplied with a finned seal for on-site assembly. This seal is not compatible with UG438.

110mm Shallow Access Chambers (Depth should not exceed 600mm) (Sockets include captive ring seal for chamfered pipes)	Code	Pack Qty.	Bulk Qty.	Product Group	Price Each £	
320mm. Chamber Base with 2 x 45° side branch inlets (170mm with 2 blanking plugs).	UG437	1	48	51M	51.80	
320mm. Chamber Base with 4 side branch inlets - 2 x 45° & 2 x 90° (170mm with 3 blanking plugs).	UG537	1	54	51M	84.57	
320mm Side Riser (135mm) complete with seal for on-site assembly	 UG466	1	81	51M	34.03	
320mm. Riser Sealing Ring (For Dry Fix to UG466 only, not compatible with UG438).	 UG388B	1	50	51M	6.97	
320mm. Side Riser (135mm).	UG438*	1	81	51M	27.16	
320mm. Riser Sealing Ring (For Dry Fix to UG438 only, not compatible with UG466).	UG388	5	50	51M	6.97	
320mm. Circular Concrete Cover & PP Frame [A].	UG439	1	45	51M	84.82	
320mm. Aluminium Sealed Cover & Frame [C].	UG436	1	10	51M	100.51	
320mm. Square Concrete Cover & PP Frame [A].	UG499	1	45	51M	102.63	
320mm. Round PVC Cover and Frame [C] (Complete with seal and fixing screws).	 UG501	1	5	51M	93.09	
320mm. Square PVC Cover and Frame [C] (Complete with seal and fixing screws).	 UG502	1	5	51M	86.92	
320mm. Plastic Frame to Riser Fixing Kit .	FRK504	1	10	51M	15.73	

Ductile Iron Cover B125 & Recessed Pavior Cover	Code	Pack Qty.	Bulk Qty.	Product Group	Price Each £	
320mm. Ductile Iron Cover & PP Frame (EN124/Class B125).	UDC700	1	1	51M	233.87	
320mm . Recessed Pavior Cover Polypropylene Frame and Tray 390 x 390.	URP720	1	1	51M	231.32	

\* To be discontinued quarter two 2019

**NOTE:** Spare screws for UG501 & UG502 see page 79

# Drainage

## Inspection Chambers, Covers and Frames

Polypropylene Black unless otherwise stated.



### Loading Classification for Cover and Frames

A = Equivalent to Class A15 load category of BS EN 124-1 2015 (Pedestrians & pedal cyclists only)

A+ = Tested to withstand 35kN test load (Light vehicular traffic on domestic drives)

C = Tested to withstand 10kN test load (non-vehicular traffic only)

B125 = Class B125 load category of BS EN 124-1 2015 (Driveways, Footways & Landscaped Areas)

† A rubber sealing ring (UG488) must be used on all 460mm dia. riser and chamber base joints.

110mm & 160mm Inspection Chambers (Depth should not exceed 1.00m) (Sockets include captive ring seal for chamfered pipes)	Code	Pack Qty.	Bulk Qty.	Product Group	Price Each £	
460mm. 110mm Chamber Base with 4 side branch inlets - 2 x 45° & 2 x 90° (220mm with 3 blanking plugs).	UG440†	1	20	51M	120.95	 UG440
460mm. 160mm Chamber Base with 4 side branch inlets - 2 x 110mm x 45° & 2 x 160mm x 90° (258mm with 4 blanking plugs).	UG670†	1	20	51M	155.55	 UG670
460mm. Side Riser (215mm).	UG431†	1	20	51M	59.65	 UG431
460mm. Riser Sealing Ring (For Dry Fix to UG431).	UG488	5	50	51M	7.50	 UG488
460mm. Round Cast Iron Cover & Cast Iron Frame [A].	UG419	1	10	51M	156.35	 UG419
460mm. Round Cast Iron Cover & Polypropylene Frame [A].	UG444	1	100	51M	162.29	 UG444
460mm. Round Concrete Cover & Polypropylene Frame [A].	UG497	1	20	51M	117.62	 UG497
460mm. Square Cover and 65mm Deep Frame Polypropylene [A+]. Complete with cover to frame O ring seal and fixing screws with 350mm restricted access (removable) for depths greater than 1.2metres.	UG510 	1	5	51M	161.89	 UG510
460mm. Frame to Riser seal for UG510 Square Cover and Frame	UG515 	1	1	51M	8.15	 UG515
460mm. Round Polypropylene Screw down cover & frame BS7158 [A+].	UG511	1	1	51M	124.82	 UG511
460mm. Square Ductile Iron Cover and Frame (B125).	UG513	1	1	51M	392.30	 UG513
460mm. Plastic Frame to Riser Fixing Kit (for use with UG511).	FRK500	1	10	51M	16.62	
460mm. Spare Black Ties (30) (for FRK 500) - Not suitable for Cast Iron Frames.	FRK501	30	10	51M	0.19	
Key Lifting and Handle.	CLH500	1	1	51M	9.97	

NOTE: Spare screws for UG510 see page 79

# Drainage

## Inspection Chambers, Covers and Frames

Polypropylene Black unless otherwise stated.



\* **Riser Joints:** Sealant conforming to BS EN ISO 11600 should be used for jointing rectangular riser sections.

Ductile Iron Cover B125 & Recessed Pavior Cover	Code	Pack Qty.	Bulk Qty.	Product Group	Price Each £	
460mm. Round Ductile iron cover & frame (EN124 / Class B125).	UDC750	1	1	51M	357.14	 UDC750
460mm. Square Recessed Pavior Cover Polypropylene Frame BS729 Galvanised Steel Tray 540mm x 540mm.	URP760	1	1	51M	214.55	 URP760
110mm Rectangular Inspection Chamber (Depth should not exceed 1.00m) (Sockets include seal for chamfered pipes) (Main channel inlet & outlet are plain end and require couplers or socketed pipes)	Code	Pack Qty.	Bulk Qty.	Product Group	Price Each £	
610 x 460mm. Chamber Base with 4 side branch inlets - 2 x LH & 2 x RH x 90° (330mm with 3 blanking plugs).	UG490*	1	10	51M	167.11	 UG490
610 x 460mm. Side Riser (180mm).	UG491*	1	40	51M	106.88	
610 x 460mm. Steel Cover & PP Frame [A].	UG496	1	10	51M	182.85	
750mm Manhole Base	Code	Pack Qty.	Bulk Qty.	Product Group	Price Each £	
750mm. Circular Manhole Base 2 x 45° & 2 x 90° (MDPE) Closed Branch Inlets 160mm Spigot. (Depth not to exceed 10m).	UG616	1	5	51M	447.21	
Spare Blanking Plugs	Code	Pack Qty.	Bulk Qty.	Product Group	Price Each £	
110mm. Polypropylene for 110mm fits UG437, UG440, UG490 & UG670 Bases.	UG445	1	10	51M	8.41	
160mm. Polypropylene for 160mm Chamber Bases, Pipes and Fittings.	UG645	1	10	51M	8.97	

# Drainage

## Inspection Chambers, Covers and Frames

- Polypropylene Black unless otherwise stated.



KM061546

Polypipe

### Loading Classification for Cover and Frames

A = Equivalent to Class A15 load category of BS EN 124-1 2015 (Pedestrians & pedal cyclists only)

A+ = Tested to withstand 35kN test load (Light vehicular traffic on domestic drives)

C = Tested to withstand 10kN test load (non-vehicular traffic only)

B125 = Class B125 load category of BS EN 124-1 2015 (Driveways, Footways & Landscaped Areas)

† A rubber sealing ring (UG488) must be used on all 460mm dia. riser and chamber base joints.

### 110mm, 150mm and 160mm Non Man Entry Deep Inspection Chambers (For use at depths exceeding 1.00m but less than 4.00m)

	Code	Pack Qty.	Bulk Qty.	Product Group	Price Each £
460mm. 110mm Chamber Base with 5 inlets (inc. 3 blanking plugs, base & 4 risers -1060mm high) Suitable for Single Wall Pipes.	ICDB3	1	1	51M	626.87
460mm. 150mm Chamber Base with 2 x 110mm 45° inlets & 2 x 150mm 90° open inlets (inc. 2 blanking plugs, base & 4 risers -1060mm high) Suitable for Polysewer Structured Wall Pipes.	ICDB1	1	4	51M	626.87
460mm. 160mm Chamber Base with 2 x 110mm 45° inlets & 2 x 160mm 90° inlets (inc. 4 blanking plugs, base & 4 risers - 1060mm high) Suitable for Single Wall Pipes.	ICDB2	1	4	51M	626.87
460mm. Single Riser - 215mm effective height.	ICDR1	1	40	51M	78.94
460mm. Two Riser - 430mm effective height.	ICDR2	1	16	51M	165.71
460mm. Four Riser - 860mm effective height.	ICDR4	1	8	51M	339.27
460mm. Eight Riser - 1720mm effective height.	ICDR8	1	4	51M	686.35
460mm. Riser Sealing Ring.	UG488	1	10	51M	7.50
460mm. Square Cover and 65mm Deep Frame Polypropylene [A+]. Complete with cover to frame O ring seal and fixing screws with 350mm restricted access (removable) for depths greater than 1.2metres.	UG510	1	5	51M	161.89
460mm. Frame to Riser seal for UG510 Square Cover and Frame	UG515	1	1	51M	8.15
460mm. Round Polypropylene Screw down cover & frame BS7158 [A+].	UG511	1	1	51M	124.82
460mm. Square Ductile Iron Cover and Frame (B125).	UG513	1	1	51M	392.30
460mm. Plastic Frame to Riser Fixing Kit (for use with UG511).	FRK500	1	10	51M	16.62
460mm. Riser to Riser Fixing Kit - use 1 kit per riser.	FRK503	1	10	51M	33.23
460mm. Restricted Access Reducer (reduces chamber opening to a maximum of 350mm to prevent man entry).	UG514	1	1	51M	88.07



ICDB3



ICDB1



ICDR1



ICDR2



ICDR4



FRK500



UG514

# Drainage

## SFA7 Inspection Chambers, Covers and Frames Polypropylene - Black unless otherwise stated



KM585205



200mm Inspection Chamber (Depth should not exceed 2.0m)	Code	Pack Qty.	Bulk Qty.	Product Group	Price Each £	
200mm. Side Riser (2m effective height).	SFA238	1	1	51M	129.63	 <p>SFA210</p>
200mm. 110mm Chamber Base with 2 connections (inlet & outlet).	SFA210	1	1	51M	172.83	
200mm. Square Cover and Frame (EN124/Class B125).	UDC200	1	1	51M	271.60	

### Loading Classification for Cover and Frames



A = Equivalent to Class A15 load category of BS EN 124-1 2015 (Pedestrians & pedal cyclists only)

A+ = Tested to withstand 35kN test load (Light vehicular traffic on domestic drives)

C = Tested to withstand 10kN test load (non-vehicular traffic only)

B125 = Class B125 load category of BS EN 124-1 2015 (Driveways, Footways & Landscaped Areas)

**Riser Joints:** We recommend a rubber sealing ring (UG388) should be used on all 320mm dia. riser & chamber base joints. Also sealant conforming to BS EN ISO 11600 can be used for jointing the riser sections. To ensure an adequate seal it is imperative that the gap between the two fins on risers is filled excessively with sealant and any excess, following location, should be smothered around the joints.

320mm Inspection Chamber (Depth should not exceed 2.0m)	Code	Pack Qty.	Bulk Qty.	Product Group	Price Each £	
320mm. 110mm Chamber Base with 2 x 45° base & 6 risers – 1010mm high).	SFA430	1	1	51M	459.32	 <p>SFA430</p>
320mm. 110mm Chamber Base with 4 side branch inlets - 2 x 45° & 2 x 90° (inc. 3 blanking plugs base & 6 risers – 1010mm high).	SFA530	1	1	51M	524.94	
320mm. Side Riser (135mm effective height).	SFA431	1	1	51M	49.68	
320mm. Two Riser (270mm effective height).	SFA432	1	1	51M	99.36	 <p>UDC700</p>
320mm. Four Riser (540mm effective height).	SFA434	1	1	51M	198.74	
320mm. Seven Riser (945mm effective height).	SFA437	1	1	51M	347.77	 <p>UG499</p>
320mm. Riser Sealing Ring.	UG388	1	50	51M	6.97	
320mm. Ductile Iron Cover & PP Frame (EN124/Class B125).	UDC700	1	1	51M	233.87	
320mm. Circular Concrete Cover & PP Frame [A].	UG439	1	45	51M	84.82	
320mm. Square Concrete Cover & PP Frame [A].	UG499	1	45	51M	102.63	

# Drainage

## SFA7 Inspection Chambers, Covers and Frames Polypropylene - Black unless otherwise stated



KM585205



### Loading Classification for Cover and Frames

A = Equivalent to Class A15 load category of BS EN 124-1 2015 (Pedestrians & pedal cyclists only)





A+ = Tested to withstand 35kN test load (Light vehicular traffic on domestic drives)

C = Tested to withstand 10kN test load (non-vehicular traffic only)

B125 = Class B125 load category of BS EN 124-1 2015 (Driveways, Footways & Landscaped Areas)

† A rubber sealing ring (UG488) must be used on all 460mm dia. riser and chamber base joints.

\* **Riser Joints:** Sealant conforming to BS EN ISO 11600 should be used for jointing rectangular riser sections.

460mm Inspection Chamber (Depth should not exceed 3.0m)	Code	Pack Qty.	Bulk Qty.	Product Group	Price Each £	
460mm. 110mm Chamber Base with 5 inlets (inc. 3 blanking plugs, base & 4 risers -1060mm high) Suitable for Single Wall Pipes.	SFA440	1	1	51M	721.79	
460mm. 160mm Chamber Base with 2 x 110mm 45° inlets & 2 x 160mm 90° inlets (inc. 4 blanking plugs, base & 4 risers - 1060mm high) Suitable for Single Wall Pipes.	SFA670	1	1	51M	721.79	
460mm. 150mm Chamber Base with 2 x 110mm 45° inlets & 2 x 150mm 90° open inlets (inc. 2 blanking plugs, base & 4 risers -1060mm high) Suitable for Polysewer Structured Wall Pipes.	SFA671	1	1	51M	721.79	
460mm. Single Riser (215mm effective height).	SFA441	1	1	51M	57.42	
460mm. Two Riser (430mm effective height).	SFA442	1	1	51M	114.84	
460mm. Four Riser (860mm effective height).	SFA444	1	1	51M	229.65	
460mm. Eight Riser (1720mm effective height).	SFA448	1	1	51M	459.32	
460mm. Riser Sealing Ring.	UG488	5	50	51M	7.50	
460mm. Square Ductile Iron Cover and Frame (B125).	UG513	1	1	51M	392.30	
460mm. Ductile iron cover & frame (EN124 / Class B125).	UDC750	1	1	51M	357.14	
460mm. Restricted Access Reducer (reduces chamber opening to a maximum of 350mm to prevent man entry).	UG514	1	1	51M	88.07	
460mm. Cast Iron Cover & Cast Iron Frame [A].	UG419	1	10	51M	156.35	
460mm. Cast Iron Cover & Polypropylene Frame [A].	UG444	1	100	51M	162.29	

SFA440

SFA670

UG513





UDC750



# Drainage NEW

SFA7 Pipe Riser Inspection Chambers -  
Polypropylene - Terracotta unless otherwise stated



110mm, 150mm and 160mm Non Man Entry Deep Inspection Chambers (For use at depths up to 3.00m)	Code	Pack Qty.	Bulk Qty.	Product Group	Price Each £	
450mm dia. base with 110mm straight channel, 2 x 110mm 45° inlets & 2 x 110mm 90° inlets Supplied with 450mm riser seal & 4 x 110mm blanking plugs. Suitable for Single Wall Pipes.	SFARB3	1	8	161M	152.70	
450mm dia. base with 150mm straight channel, 2 x 110mm 45° inlets & 2 x 150mm 90° open inlets Supplied with 450mm riser seal & 2 x 110mm blanking plugs. Suitable for Polysewer Structured Wall Pipes.	SFARB1	1	8	161M	176.70	
450mm dia. base with 160mm straight channel, 2 x 110mm 45° inlets & 2 x 160mm 90° inlets Supplied with 450mm riser seal, 2 x 110mm & 2 x 160mm blanking plugs. Suitable for Single Wall Pipes.	SFARB2	1	8	161M	152.70	
450mm dia. riser cap, suitable for UG510 cover & frames. Supplied with 450mm riser seal. Compatible with UG514 restrictor ring to 350mm.	SFARC	1	12	161M	98.68	
450mm dia. riser 3m long. For use with all SFARB bases.	RSW450X3PE8	1	1	161M	260.00	
Spare 450mm dia. riser to base seal EPDM. For use with RSW450X3PE8.	SRSW4508	1	10	161M	33.27	

## Square Chamber Cover UG510



The UG510 square cover and frame, manufactured from polypropylene for loadings up to 35kN [A+] with 65mm deep frame for ease of installation in block paving, complete with a removable 350mm restrictor ring for chambers greater than 1.2m. Optional finned gasket UG515 available to give a frame to riser seal.



# Drainage

## IC600 Pipe Riser Inspection Chambers - Polypropylene - Terracotta unless otherwise stated



150/160mm, 225/250mm, 300/315mm Non Man Entry Deep Inspection Chambers (For use at depths up to 3.00m)	Code	Pack Qty.	Bulk Qty.	Product Group	Price Each £	
IC600 Base with Straight channel for use with 150mm Polysewer or 160mm Underground (requires adaptor ICPS6 or ICUG6 and SRSW6008 Seal).	IC6BS6	1	2	161M	568.42	 IC6BS6
IC600 Base with Straight channel for use with 225mm Polysewer or 250mm Sewerdrain (requires adaptor ICPS10 or ICUG10 and SRSW6008 Seal).	*IC6BS10	1	2	161M	705.26	 IC6BS10
IC600 Base with Straight channel for use with 300mm Polysewer (requires adaptor PS12102) or 315mm Sewerdrain (direct connection) and SRSW6008 Seal. Black.	IC6BS12	1	2	161M	948.42	 IC6BS12
IC600 Base with Straight channel and two equal 90° branch entries, for use with 150mm Polysewer or 160mm Underground (requires adaptor ICPS6, ICUG6, or End Cap IC6EC6 and SRSW6008 Seal).	IC6CRS6	1	2	161M	584.21	 IC6CRS6
IC600 Base with Straight channel and two equal 90° branch entries, for use with 225mm Polysewer or 250mm Sewerdrain (requires adaptor ICPS10, ICUG10, or End Cap IC6EC10 and SRSW6008 Seal).	IC6CRS10	1	2	161M	731.58	 IC6CRS10
IC600 Base with Straight channel and two equal 90° branch entries, for use with 300mm Polysewer (requires adaptor PS12102), 315mm Sewerdrain (direct connection), or End Cap UG1220 and SRSW6008 Seal. Black.	IC6CRS12	1	2	161M	948.42	 IC6CRS12
600mm dia. riser 3m long. For use with all IC600 bases.	RSW600X3PE8	1	1	161M	394.74	 RSW600X3PE8
600mm dia. riser to base seal EPDM. For use with RSW600X3PE8 and Riser Cap IC6RC.	SRSW6008	1	1	161M	39.47	 SRSW6008
IC600 Base adaptor to 150mm Polysewer	IC6PS6	1	10	161M	18.42	 IC6PS10
IC600 Base adaptor to 160mm Underground	IC6UG6	1	10	161M	18.42	
IC600 Base adaptor to 225mm Polysewer	IC6PS10	1	10	161M	35.53	
IC600 Base adaptor to 250mm Underground	IC6UG10	1	10	161M	35.53	
IC600 Base adaptor to 300mm Polysewer	PS12102	1	1	161M	58.95	
IC600 riser cap, suitable for UG510 cover & frames. Compatible with UG514 restrictor ring to 350mm. Requires Seal SRSW6008.	IC6RC	1	1	161M	149.50	 IC6RC
IC600 Base End Cap for IC6BS6 and IC6CRS6.	IC6EC6	1	1	161M	18.42	 IC6EC6
IC600 Base End Cap for IC6BS10 and IC6CRS10.	IC6EC10	1	1	161M	35.53	
315mm End Cap/Socket Plug for IC6BS12 and IC6CRS12	UG1220	1	1	53M	117.62	

\* Available quarter three 2019.

# Drainage

## Polysewer Gravity Sewer System - PVCu

Terracotta brown unless otherwise stated



Polypipe

Pipe - Higher Stiffness Class 8	Code	Pack Qty.	Bulk Qty.	Product Group	Price Each £
150mm. 6m Plain Ended.	PS660	1	46	160E	75.90
150mm. 6m Integral Socket.	PS662	1	46	160E	87.09
150mm. 3m Plain Ended.	PS630	1	46	160E	37.93
150mm. 3m Integral Socket.	PS632	1	46	160E	41.65
225mm. 6m Plain Ended.	PS1060	1	23	160E	206.74
225mm. 6m Integral Socket.	PS1062	1	23	160E	219.80
225mm. 3m Plain Ended.	PS1030	1	23	160E	103.33
225mm. 3m Integral Socket.	PS1032	1	23	160E	106.82
300mm. 6m Plain Ended.	PS1260	1	8	160E	315.20
300mm. 6m Integral Socket.	PS1262	1	8	160E	335.85
300mm. 3m Plain Ended.	PS1230	1	8	160E	148.88
300mm. 3m Integral Socket.	PS1232	1	8	160E	162.22





PS662

Couplers	Code	Pack Qty.	Bulk Qty.	Product Group	Price Each £
150mm. Pipe Coupler.	PS601	1	10	161M	22.13
150mm. Slip Coupler.	PS600	1	10	161M	22.13
225mm. Pipe Coupler.	PS1001	1	1	161M	53.99
225mm. Slip Coupler.	PS1000	1	1	161M	53.99
300mm. Pipe Coupler.	PS1201	1	1	161M	109.83
300mm. Slip Coupler.	PS1200	1	1	161M	109.83



PS601

Reducers	Code	Pack Qty.	Bulk Qty.	Product Group	Price Each £
150mm. 150mm x 110mm Level Invert. 	PS621	1	1	161M	45.55
225mm. 225mm x 150mm Level Invert.	PS1021	1	1	161M	132.74
300mm. 300mm x 225mm Level Invert.	PS1221	1	1	161M	242.33



Triple Socket Equal Junctions	Code	Pack Qty.	Bulk Qty.	Product Group	Price Each £
150mm. 45° Equal Junction.	PS605	1	5	161M	77.35
150mm. 90° Equal Junction.	PS623	1	5	161M	77.35
225mm. 45° Equal Junction.	PS1005	1	1	161M	294.57
300mm. 45° Equal Junction.	PS1205	1	1	161M	630.26



PS605

# Drainage

## Polysewer Gravity Sewer System - PVCu

Terracotta brown unless otherwise stated

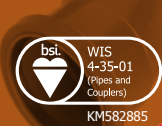

Polypipe

Triple Socket Unequal Junctions (45° unless stated)	Code	Pack Qty.	Bulk Qty.	Product Group	Price Each £	
150mm x 110mm EN1401-1.	PS635RS	1	5	161M	71.14	
150mm x 110mm EN1401-1 (92½°).	PS643RS	1	5	161M	71.14	
225mm x 110mm EN1401-1.	PS1035RS	1	1	161M	219.07	
225mm x 150mm.	PS1031	1	1	161M	183.18	
225mm x 160mm EN1401-1.	PS1031RS	1	1	161M	198.09	
300mm x 110mm EN1401-1.	PS1235RS	1	1	161M	363.90	
300mm x 150mm.	PS1231	1	1	161M	297.99	
300mm x 160mm EN1401-1.	PS1231RS	1	1	161M	327.47	
300mm x 225mm.	PS12100	1	1	161M	599.93	

Double Socket Short Radiused Bends	Code	Pack Qty.	Bulk Qty.	Product Group	Price Each £	
150mm. 90° Bend.	PS611	1	5	161M	44.46	
150mm. 45° Bend.	PS603	1	10	161M	38.01	
150mm. 30° Bend.	PS667	1	10	161M	38.01	
150mm. 15° Bend.	PS609	1	10	161M	38.01	
225mm. 90° Bend.	PS1011	1	1	161M	198.08	
225mm. 45° Bend.	PS1003	1	1	161M	153.47	
225mm. 30° Bend.	PS1067	1	1	161M	156.67	
225mm. 15° Bend.	PS1009	1	1	161M	152.16	
300mm. 90° Bend.	PS1211	1	1	161M	345.03	
300mm. 45° Bend.	PS1203	1	1	161M	269.00	
300mm. 30° Bend.	PS1267	1	1	161M	261.15	
300mm. 15° Bend.	PS1209	1	1	161M	248.20	

Rodding Eye	Code	Pack Qty.	Bulk Qty.	Product Group	Price Each £	
150mm. Sealed oval top (Aluminium) 45°.	PS622S	1	8	161M	180.84	

150mm Chamber Base 460mm diameter	Code	Pack Qty.	Bulk Qty.	Product Group	Price Each £	
150mm. 150mm Main Channel 2 x 110mm inlets 45°, 2 x 150mm inlets 90°. Use with standard 460mm risers (UG431) and covers.	PS670	1	8	161M	192.82	



# Drainage

## Polysewer Gravity Sewer System - PVCu

Terracotta brown unless otherwise stated





Polypipe

Adaptors	Code	Pack Qty.	Bulk Qty.	Product Group	Price Each £	
150mm. Double Socket to SuperSleve Clayware Pipe.	PS634	1	20	161M	58.95	 PS634
150mm. Double Socket to Thick Clayware Pipe.	PS696	1	20	161M	58.95	
For connection to 225mm clay pipes use flexible connector XAC160/230. For connection to 300mm clay pipes use flexible connector XAC160/320.						
150mm. Double Socket to EN1401-1 Pipe (160mm).	PS689	1	10	161M	58.95	 PS689
225mm. Double Socket to EN1401-1 Pipe (250mm).	PS1089	1	1	161M	58.95	
300mm. Double Socket to EN1401-1 Pipe (315mm).	PS1289	1	1	161M	58.95	 PS10102
225mm. Polysewer Single Socket for connection to EN1401-1 Socket (250mm Spigot).	PS10102	1	1	161M	58.95	
300mm. Polysewer Single Socket for connection to EN1401-1 Socket (315mm Spigot).	PS12102	1	1	161M	58.95	

Ultrarib Adaptor	Code	Pack Qty.	Bulk Qty.	Product Group	Price Each £	
150mm. Double Socket.	PS6105	1	10	161M	58.95	
225mm. Double Socket.	PS10105	1	1	161M	58.95	
300mm. Double Socket.	PS12105	1	1	161M	58.95	

Ultrarib Adaptor Seals (for using Polysewer in Ultrarib Sockets)	Code	Pack Qty.	Bulk Qty.	Product Group	Price Each £	
150mm. Adaptor Seal.	PSUR150	1	10	161M	26.88	
225mm. Adaptor Seal.	PSPP2	1	10	161M	5.61	
300mm. Adaptor Seal.	PSUR300	1	10	161M	44.40	

End Caps	Code	Pack Qty.	Bulk Qty.	Product Group	Price Each £	
150mm.	PS6101	1	10	161M	16.22	
225mm.	PS10101	1	1	161M	81.36	
300mm.	PS12101	1	1	161M	110.95	

Socket Plug	Code	Pack Qty.	Bulk Qty.	Product Group	Price Each £	
150mm.	PS620	1	10	161M	38.63	
225mm.	PS1020	1	1	161M	113.99	
300mm.	PS1220	1	1	161M	200.63	

Spare Polysewer Seals	Code	Pack Qty.	Bulk Qty.	Product Group	Price Each £	
150mm.	PSSP1	1	10	161M	2.77	
225mm.	PSSP2	1	10	161M	5.61	
300mm.	PSSP3	1	10	161M	11.63	

# Drainage

## Polysewer Gravity Sewer System - PVCu

Terracotta brown unless otherwise stated



 **Polypipe**

Snap Cap and Seals	Code	Pack Qty.	Bulk Qty.	Product Group	Price Each £	
150mm. To accept EN1401-1 solid wall pipes and to adapt to 90° junctions for use with PS623, PS643RS, PS634, PS696, PS6225 & PS670.	PS6104	1	10	161M	15.58	
150mm. To accept EN1401-1 solid wall pipes and to adapt to 90° bends & 45° unequal junctions.	PS6103	1	10	161M	15.58	
150mm. To accept 150mm Polysewer pipes - for converting ICDB2.	PSC1	1	10	161M	3.38	

# Drainage

## Sewerdrain Gravity Sewer System - PVCu

Terracotta brown unless otherwise stated



KM06383



Single Socket Pipe	Code	Pack Qty.	Bulk Qty.	Product Group	Price Each £
200mm. 3m length.	UG832	1	23	52E	76.73
200mm. 6m length.	UG862	1	23	52E	151.93
250mm. 3m length.	UG1032	1	14	52E	104.00
250mm. 6m length.	UG1062	1	14	52E	205.92
315mm. 3m length.	UG1232	1	8	52E	162.00
315mm. 6m length.	UG1262	1	8	52E	320.76



Plain Ended Pipe	Code	Pack Qty.	Bulk Qty.	Product Group	Price Each £
200mm. 3m length.	UG830	1	23	52E	72.90
200mm. 6m length.	UG860	1	23	52E	145.79
250mm. 3m length.	UG1030	1	14	52E	101.40
250mm. 6m length.	UG1060	1	14	52E	202.80
315mm. 3m length.	UG1230	1	8	52E	149.85
315mm. 6m length.	UG1260	1	8	52E	299.70



Perforated Pipe	Code	Pack Qty.	Bulk Qty.	Product Group	Price Each £
200mm. 6m single socketed.	UG869	1	23	52E	218.69
250mm. 6m single socketed.	UG1069	1	14	52E	304.20
315mm. 6m single socketed.	UG1269	1	8	52E	449.55



Manhole Connector	Code	Pack Qty.	Bulk Qty.	Product Group	Price Each £
200mm. 600mm length Sand coated one end.	UGT899	1	1	52E	21.30
250mm. 600mm length Sand coated one end.	UGR1099	1	1	52E	29.23
315mm. 600mm length Sand coated one end.	UGR1299	1	1	52E	51.42

MADE TO ORDER  
IN 14 DAYS

Couplers	Code	Pack Qty.	Bulk Qty.	Product Group	Price Each £
200mm. Double Socket (Remove Centre Stop for use as Slip Coupling).	UG801	1	10	53M	37.03
250mm. Double Socket (Remove Centre Stop for use as Slip Coupling).	UG1001	1	5	53M	53.00
315mm. Double Socket.	UG1201	1	1	53M	102.00
315mm. Slip Coupler (Double Socket).	UG1200	1	1	53M	102.00



UG801

# Drainage



## Sewerdrain Gravity Sewer System - PVCu

Terracotta brown unless otherwise stated





KM06383



Single Socket Bends	Code	Pack Qty.	Bulk Qty.	Product Group	Price Each £	
200mm. 87½° Single Socket.	UG812	1	1	53M	48.22	 UG812
200mm. 45° Single Socket.	UG804	1	1	53M	48.22	
200mm. 30° Single Socket.	UG868	1	1	53M	43.40	
200mm. 15° Single Socket.	UG810	1	1	53M	43.40	 UG804
250mm. 87½° Single Socket.	UG1012	1	1	53M	179.62	
250mm. 45° Single Socket.	UG1004	1	1	53M	179.62	
250mm. 30° Single Socket.	UG1068	1	1	53M	143.70	 UG868
250mm. 15° Single Socket.	UG1010	1	1	53M	143.70	
315mm. 87½° Single Socket.	UG1212	1	1	53M	275.19	
315mm. 45° Single Socket.	UG1204	1	1	53M	275.19	
315mm. 30° Single Socket.	UG1268	1	1	53M	192.63	
315mm. 15° Single Socket.	UG1210	1	1	53M	192.63	

Double Socket Bends	Code	Pack Qty.	Bulk Qty.	Product Group	Price Each £	
200mm. 45° Double Socket.	UG803	1	1	53M	57.87	
200mm. 15° Double Socket.	UG809	1	1	53M	52.08	

Equal Junctions	Code	Pack Qty.	Bulk Qty.	Product Group	Price Each £	
200mm. 45° Double Socket.	UG806	1	1	53M	120.29	 UG806
200mm. 45° Triple Socket.	UG805	1	1	53M	126.30	
250mm. 45° Double Socket.	UG1006	1	1	53M	292.51	
315mm. 45° Double Socket.	UG1206	1	1	53M	462.37	

Unequal Junctions	Code	Pack Qty.	Bulk Qty.	Product Group	Price Each £	
200mm. 45° Double Socket (110mm).	UG836	1	1	53M	85.51	 UG836
200mm. 45° Double Socket (160mm).	UG837	1	1	53M	85.51	
200mm. 45° Triple Socket (110mm).	UG835	1	1	53M	85.51	 UG831
200mm. 45° Triple Socket (160mm).	UG831	1	1	53M	85.51	
250mm. 45° Double Socket (110mm).	UG1036	1	1	53M	191.00	
250mm. 45° Double Socket (160mm).	UG1016	1	1	53M	207.61	
250mm. 45° Double Socket (200mm).	UG1017	1	1	53M	280.28	
315mm. 45° Double Socket (110mm).	UG1236	1	1	53M	332.91	
315mm. 45° Double Socket (160mm).	UG1216	1	1	53M	332.91	
315mm. 45° Double Socket (200mm).	UG1217	1	1	53M	369.90	
315mm. 45° Double Socket (250mm).	UG1218	1	1	53M	369.90	



# Drainage

## Sewerdrain Gravity Sewer System - PVCu

Terracotta brown unless otherwise stated



KM06383



Plain Socket Plugs	Code	Pack Qty.	Bulk Qty.	Product Group	Price Each £	
200mm.	UG820	1	1	53M	21.46	
250mm.	UG1020	1	1	53M	65.88	
315mm.	UG1220	1	1	53M	117.62	

Level Invert Reducers	Code	Pack Qty.	Bulk Qty.	Product Group	Price Each £	
200mm Spigot x 160mm Socket	UG821	1	1	53M	48.58	
250mm Spigot x 200mm Socket	UG1021	1	1	53M	84.22	
315mm Spigot x 250mm Socket	UG1221	1	1	53M	131.61	

# Drainage

## Flexicon - Flexible Rubber Couplers and Adaptors



Polypipe

Flexicon Universal Adaptors (XAC)	Code	Pack Qty.	Screwdriver Size	Product Group	Price Each £	
Range A/B mm	Min Length C mm					
120-135/100-115.	100	XAC400	1	7mm / 7mm	107M	28.59
180-200/160-180.	150	XAC600	1	8mm / 8mm	107M	73.45
260-285/180-205.	150	XAC800	1	8mm / 8mm	107M	127.74



XAC400

Flexicon Universal Adaptors (XAC)	Code	Pack Qty.	Screwdriver Size	Product Group	Price Each £	
Range A/B mm	Min Length C mm					
100-115/75-85.	100	XAC85/115	1	7mm / 7mm	107M	45.24
100-115/85-95.	100	XAC95/115	1	7mm / 7mm	107M	45.96
130-145/110-125.	120	XAC125/145	1	7mm / 7mm	107M	59.22
145-160/110-125.	120	XAC125/160	1	7mm / 7mm	107M	60.18
145-160/125-140.	120	XAC140/160	1	7mm / 7mm	107M	68.90
150-165/100-115.	120	XAC115/165	1	7mm / 7mm	107M	63.82
160-175/110-125.	120	XAC125/175	1	7mm / 7mm	107M	70.24
170-185/145-160.	120	XAC160/185	1	7mm / 7mm	107M	74.76
175-190/110-125.	120	XAC125/190	1	7mm / 7mm	107M	73.26
175-190/125-140.	120	XAC140/190	1	7mm / 7mm	107M	75.23
180-195/160-175.	120	XAC175/195	1	7mm / 7mm	107M	79.50
190-205/110-125.	150	XAC125/205	1	8mm / 7mm	107M	78.94
195-210/160-175.	150	XAC175/210	1	8mm / 7mm	107M	86.16
215-230/125-140.	150	XAC140/230	1	8mm / 7mm	107M	99.42
215-230/145-160.	150	XAC160/230	1	8mm / 7mm	107M	108.50
213-230/175-190.	150	XAC190/230	1	8mm / 8mm	107M	110.95
230-245/125-140.	150	XAC140/245	1	8mm / 7mm	107M	107.68
230-245/145-160.	150	XAC160/245	1	8mm / 7mm	107M	114.74
230-245/175-190.	150	XAC190/245	1	8mm / 8mm	107M	123.33
245-260/145-160.	150	XAC160/260	1	8mm / 7mm	107M	116.78
245-260/175-190.	150	XAC190/260	1	8mm / 8mm	107M	121.44
265-280/145-160.	150	XAC160/280	1	8mm / 8mm	107M	140.44
260-285/240-265.	150	XAC900	1	8mm / 8mm	107M	139.75
305-320/145-160.	150	XAC160/320	1	8mm / 8mm	107M	143.55
305-320/175-190.	150	XAC190/320	1	8mm / 8mm	107M	144.87



XAC85

# Drainage

## Flexicon - Flexible Rubber Couplers and Adaptors



Flexicon Plumbing Adaptors (XPA)	Code	Pack Qty.	Screwdriver Size	Product Group	Price Each £	
Range A/B mm	Min Length C mm					
50-65/30-45.	80	XPA45/65	1	7mm / 7mm	107M	24.68
80-95/45-50.	100	XPA50/95	1	7mm / 7mm	107M	29.41
100-115/45-50.	100	XPA50/115	1	7mm / 7mm	107M	31.32
80-95/50-65.	100	XPA65/95	1	7mm / 7mm	107M	31.72
100-115/50-65.	100	XPA65/115	1	7mm / 7mm	107M	35.75



XPA50

Flexicon Drain Couplings (XDR)	Code	Pack Qty.	Screwdriver Size	Product Group	Price Each £	
Range A/B mm	Min Length C mm					
50-65.	95	XDR65	1	7mm	107M	26.65
70-85.	110	XDR85	1	7mm	107M	28.08
80-95.	110	XDR95	1	7mm	107M	28.32
100-115.	110	XDR115	1	7mm	107M	27.55
110-125.	120	XDR125	1	7mm	107M	28.66
120-135.	120	XDR135	1	7mm	107M	30.34
135-150.	120	XDR150	1	7mm	107M	51.38
150-165.	120	XDR165	1	7mm	107M	51.45
160-175.	120	XDR175	1	7mm	107M	64.06
160-180.	120	XDR180	1	7mm	107M	64.72
175-200.	150	XDR200	1	8mm	107M	67.18
200-215.	150	XDR215	1	8mm	107M	72.00
200-225.	150	XDR225	1	8mm	107M	78.39
225-250.	150	XDR250	1	8mm	107M	92.74
250-275.	150	XDR275	1	8mm	107M	107.09



XDR115

# Drainage

Flexicon - Flexible Rubber Couplers and Adaptors



Polypipe

Flexicon Shear Band Standard Couplings (XSB)		Code	Pack Qty.	Screwdriver Size	Product Group	Price Each £
Range A/B mm	Min Length C mm					
100-115.	120	XSB115	1	8mm	107M	73.50
110-125.	120	XSB125	1	8mm	107M	74.44
120-135.	120	XSB135	1	8mm	107M	75.05
135-150.	120	XSB150	1	8mm	107M	110.22
150-165.	120	XSB165	1	8mm	107M	113.79
160-175.	120	XSB175	1	8mm	107M	114.34
160-180.	120	XSB180	1	8mm	107M	115.04
175-200.	150	XSB200	1	8mm	107M	115.41
190-215.	150	XSB215	1	8mm	107M	122.46
200-225.	150	XSB225	1	8mm	107M	128.47
225-250.	150	XSB250	1	8mm	107M	134.48
250-275.	150	XSB275	1	8mm	107M	138.00
265-290.	150	XSB290	1	8mm	107M	140.08
285-310.	190	XSB310	1	8mm	107M	232.57
295-320.	190	XSB320	1	8mm	107M	239.67
305-335.	190	XSB335	1	8mm	107M	248.49
315-345.	190	XSB345	1	8mm	107M	253.08
345-360.	190	XSB360	1	8mm	107M	259.24
360-385.	190	XSB385	1	8mm	107M	265.82
385-410.	190	XSB410	1	8mm	107M	284.35



XSB115

# Drainage

Flexicon - Flexible Rubber Couplers and Adaptors



KM506831 KM506832 KM37955



Flexicon End Caps (XST)		Code	Pack Qty.	Screwdriver Size	Product Group	Price Each £
Range A/B mm	Min Length C mm					
20-32.		XST32	1	7mm	107M	10.86
30-42.		XST42	1	7mm	107M	11.68
40-50.		XST50	1	7mm	107M	12.20
50-65.		XST65	1	7mm	107M	13.21
80-95.		XST95	1	7mm	107M	16.35
100-115.		XST115	1	7mm	107M	26.55
110-125.		XST125	1	7mm	107M	29.35
120-135.		XST135	1	7mm	107M	30.04
135-150.		XST150	1	7mm	107M	32.33
145-160.		XST160	1	7mm	107M	34.44
165-180.		XST180	1	7mm	107M	37.27
185-200.		XST200	1	8mm	107M	41.73
200-215.		XST215	1	8mm	107M	43.94



Flexidriver (Flexible Screwdriver)	Code	Pack Qty.	Screwdriver Size	Product Group	Price Each £
7mm Flexidriver.	XFD700	1		107M	30.56
8mm Flexidriver.	XFD800	1		107M	30.56
8mm Ridgidriver.	XTB800	1		107M	30.56



# Drainage

## Flexicon Reducing Bushes



Flexicon Reducing Bushes (XBC)	Code	Pack Qty.	Screwdriver Size	Product Group	Price Each £
11 - 16mm. Fits coupling <b>XDR65</b> .	XBC17/19	1		107M	25.82
15 - 20mm. Fits coupling <b>XDR65</b> .	XBC21/17	1		107M	25.84
20 - 25mm. Fits coupling <b>XDR65</b> .	XBC26/14	1		107M	25.82
30 - 37mm. Fits coupling <b>XDR65</b> .	XBC37/09	1		107M	23.73
35 - 40mm. Fits coupling <b>XDR65</b> .	XBC43/06	1		107M	23.73
55 - 65mm. Fits coupling <b>XSB115</b> .	XBC65/23	1		107M	44.54
65 - 76mm. Fits coupling <b>XSB115</b> .	XBC76/17	1		107M	40.49
85 - 95mm. Fits coupling <b>XSB115</b> .	XBC95/08	1		107M	36.53
55 - 65mm. Fits coupling <b>XSB120</b> .	XBC65/27	1		107M	66.44
82 - 92mm. Fits coupling <b>XSB120</b> .	XBC95/12	1		107M	46.67
92.5 - 98mm. Fits coupling <b>XSB115</b> .	XBC95/05	1		107M	8.14
95 - 105mm. Fits coupling <b>XSB115</b> .	XBC105/05	1		107M	7.96
105 - 115mm. Fits coupling <b>XSB125</b> .	XBC115/05	1		107M	8.64
115 - 125mm. Fits coupling <b>XSB135</b> .	XBC125/05	1		107M	8.80
73 - 82mm. Fits coupling <b>XDR95</b> .	XBC85/08	1		107M	10.05
83 - 92mm. Fits coupling <b>XSB115</b> .	XBC90/08	1		107M	11.06
95 - 105mm. Fits coupling <b>XSB120</b> .	XBC105/08	1		107M	35.63
107 - 117mm. Fits coupling <b>XSB135</b> .	XBC120/08	1		107M	12.23
125 - 135mm. Fits coupling <b>XSB150</b> .	XBC140/08	1		107M	14.00
140 - 150mm. Fits coupling <b>XSB165</b> .	XBC150/08	1		107M	14.14
150 - 160mm. Fits coupling <b>XSB175</b> .	XBC165/08	1		107M	14.90
175 - 185mm. Fits coupling <b>XSB200</b> .	XBC184/08	1		107M	15.81
180 - 190mm. Fits coupling <b>XSB200</b> .	XBC190/08	1		107M	16.41
200 - 210mm. Fits coupling <b>XSB225</b> .	XBC215/08	1		107M	16.86
225 - 235mm. Fits coupling <b>XSB250</b> .	XBC245/08	1		107M	17.96
245 - 255mm. Fits coupling <b>XSB275</b> .	XBC255/08	1		107M	20.09
110 - 120mm. Fits coupling <b>XSB135</b> .	XBC125/08	1		107M	12.28
110 - 120mm. Fits coupling <b>XSB150</b> .	XBC125/16	1		107M	21.34
125 - 135mm. Fits coupling <b>XSB165</b> .	XBC135/16	1		107M	23.49
135 - 145mm. Fits coupling <b>XSB175</b> .	XBC150/16	1		107M	25.37
160 - 170mm. Fits coupling <b>XSB200</b> .	XBC168/16	1		107M	28.53
160 - 170mm. Fits coupling <b>XSB215</b> .	XBC175/16	1		107M	28.43
185 - 195mm. Fits coupling <b>XSB225</b> .	XBC200/16	1		107M	30.58
210 - 220mm. Fits coupling <b>XSB250</b> .	XBC230/16	1		107M	32.14
230 - 240mm. Fits coupling <b>XSB275</b> .	XBC240/16	1		107M	34.20
170 - 180mm. Fits coupling <b>XSB225</b> .	XBC185/24	1		107M	39.39
190 - 200mm. Fits coupling <b>XSB250</b> .	XBC210/24	1		107M	41.57
205 - 215mm. Fits coupling <b>XSB250</b> .	XBC225/16	1		107M	31.30
210 - 220mm. Fits coupling <b>XSB275</b> .	XBC225/24	1		107M	43.41
265 - 275mm. Fits coupling <b>XSB290</b> .	XBC275/08	1		107M	21.37



XBC115

# Drainage

## Underground Ancillaries



Joint Lubricant	Code	Pack Qty.	Bulk Qty.	Product Group	Price Each £	
500ml bottle.	SG500	1	12	89M	26.45	
1kg Tub.	LUBX1	1	12	89M	24.39	
2.5kg Tub.	LUBX2.5	1	4	89M	60.85	
Silicone Grease	Code	Pack Qty.	Bulk Qty.	Product Group	Price Each £	
100g Screw top jar.	SG100	1	100	89M	17.55	
500g.	SIL500	1	30	89M	79.53	
Aerosol Lubricant	Code	Pack Qty.	Bulk Qty.	Product Group	Price Each £	
400ml.	SG300	1	12	89M	29.20	
Cleaning Fluid	Code	Pack Qty.	Bulk Qty.	Product Group	Price Each £	
250ml tin.	CF250	1	10	89M	14.76	
Solvent Cement	Code	Pack Qty.	Bulk Qty.	Product Group	Price Each £	
125ml tin c/w Brush (BS EN 14680:2015).	SC125	1	20	89M	13.55	
250ml tin c/w Brush (BS EN 14680:2015).	SC250	1	10	89M	20.65	
Solvent Cement	Code	Pack Qty.	Bulk Qty.	Product Group	Price Each £	
500ml tin (BS EN 14680:2015).	SC500	1	10	89M	37.42	
Clear Solvent Cement Filler	Code	Pack Qty.	Bulk Qty.	Product Group	Price Each £	
140g Tube.	GFC100	1	10	89M	17.55	

# Water Supply

## Water Service Pipes MDPE PE80



KM85017



MDPE PE80 12 Bar Pressure Pipe	Code	Pack Qty.	Bulk Qty.	Colour	Product Group	Price Each £
20mm x 25m Coil. 0.13kg/m, 2.3mm.	2025	1	22	BU B	70E	64.83
20mm x 50m Coil. 0.13kg/m, 2.3mm.	2050	1	10	BU B	70E	129.66
20mm x 100m Coil. 0.13kg/m, 2.3mm.	20100	1	6	BU B	70E	259.24
20mm x 150m Coil. 0.13kg/m, 2.3mm.	20150	1	6	BU B	70E	388.92
25mm x 25m Coil. 0.17kg/m, 2.3mm.	2525	1	8	BU B	70E	82.71
25mm x 50m Coil. 0.17kg/m, 2.3mm.	2550	1	7	BU B	70E	165.36
25mm x 100m Coil. 0.17kg/m, 2.3mm.	25100	1	6	BU B	70E	330.79
25mm x 150m Coil. 0.17kg/m, 2.3mm.	25150	1	6	BU B	70E	496.15
32mm x 25m Coil. 0.28kg/m, 3.0mm.	3225	1	9	BU B	70E	138.59
32mm x 50m Coil. 0.28kg/m, 3.0mm.	3250	1	6	BU B	70E	277.19
32mm x 100m Coil. 0.28kg/m, 3.0mm.	32100	1	5	BU B	70E	554.34
32mm x 150m Coil. 0.28kg/m, 3.0mm.	32150	1	5	BU B	70E	831.52
40mm x 50m Coil. 0.43kg/m, 3.0mm.	4050	1	1	B	70E	431.03
40mm x 100m Coil. 0.43kg/m, 3.0mm.	40100	1	1	B	70E	862.12
50mm x 6m Length. 0.67kg/m, 4.6mm.	5006	1	1	BU B	70E	79.74
50mm x 25m Coil. 0.67kg/m, 4.6mm.	5025	1	1	BU B	70E	332.08
50mm x 50m Coil. 0.67kg/m, 4.6mm.	5050	1	1	BU B	70E	664.08
50mm x 100m Coil. 0.67kg/m, 4.6mm.	50100	1	1	BU B	70E	1,328.15
50mm x 150m Coil. 0.67kg/m, 4.6mm.	50150	1	1	BU B	70E	1,992.30
63mm x 6m Length. 1.05kg/m, 5.8mm.	6306	1	1	BU B	70E	124.97
63mm x 25m Coil. 1.05kg/m, 5.8mm.	6325	1	1	BU B	70E	520.83
63mm x 50m Coil. 1.05kg/m, 5.8mm.	6350	1	1	BU B	70E	1,041.64
63mm x 100m Coil. 1.05kg/m, 5.8mm.	63100	1	1	BU B	70E	2,083.34
63mm x 150m Coil. 1.05kg/m, 5.8mm.	63150	1	1	BU B	70E	3,124.96



MDPE PE80 8 Bar Pressure Pipe	Code	Pack Qty.	Bulk Qty.	Colour	Product Group	Price Each £
50mm x 50m Coil. 0.40kg/m, 2.9mm.	500850B	1	1	B	70E	400.95
50mm x 100m Coil. 0.40kg/m, 2.9mm.	5008100B	1	1	B	70E	801.92
63mm x 50m Coil. 0.64kg/m, 3.6mm.	630850B	1	1	B	70E	641.51
63mm x 100m Coil. 0.64kg/m, 3.6mm.	6308100B	1	1	B	70E	1,283.04





# Water Supply

## Polyfast Polyethylene Compression Fittings

Adaptable for  
Polyethylene, Lead,  
Copper, PVC and  
Galvanised Iron



KM85017



Straight Coupler	Code	Pack Qty.	Bulk Qty.	Product Group	Price Each £
20mm.	40020	10	100	79M	5.03
25mm.	40025	10	50	79M	5.63
32mm.	40032	5	50	79M	13.57
40mm.	40040	2	50	79M	18.75
50mm.	40050	2	20	79M	31.05
63mm.	40063	2	20	79M	45.58



Slip/Repair Coupler	Code	Pack Qty.	Bulk Qty.	Product Group	Price Each £
20mm.	40020S	10	100	79M	7.16
25mm.	40025S	10	50	79M	8.67
32mm.	40032S	5	50	79M	18.81
40mm.	40040S	2	50	79M	26.19
50mm.	40050S	2	20	79M	39.35
63mm.	40063S	2	20	79M	54.69



Polylink Straight Universal Transition Coupler	Code	Pack Qty.	Bulk Qty.	Product Group	Price Each £
25mm x 15/22mm.	4841522	1	10	79M	17.19
25mm x 21/27mm.	4842127	1	10	79M	19.22
25mm x 27/35mm.	4842735	1	10	79M	26.32
32mm x 27/35mm.	4882735	1	10	79M	31.55



Polylink 90° Bent Universal Transition Coupler	Code	Pack Qty.	Bulk Qty.	Product Group	Price Each £
25mm x 15/22mm.	4851522	1	10	79M	17.93
25mm x 21/27mm.	4852127	1	10	79M	21.26
25mm x 27/35mm.	4852735	1	10	79M	26.32



Reducing Coupler	Code	Pack Qty.	Bulk Qty.	Product Group	Price Each £
25mm x 20mm	40625	10	100	79M	11.50
32mm x 20mm	4063220	5	10	79M	19.82
32mm x 25mm	40632	5	10	79M	19.82
40mm x 32mm	40640	2	10	79M	26.19
50mm x 32mm	4065032	2	10	79M	36.31
50mm x 40mm	40650	2	10	79M	36.31



# Water Supply

## Polyfast Polyethylene Compression Fittings

Adaptable for  
Polyethylene, Lead,  
Copper, PVC and  
Galvanised Iron



KM85017



Metric to Imperial Coupler	Code	Pack Qty.	Bulk Qty.	Product Group	Price Each £
20mm x 1/2".	48120	10	10	79M	7.56
25mm x 1/2".	4812512	10	10	79M	9.67
25mm x 3/4".	48125	10	10	79M	9.67



Imperial Male Iron x PE Coupler	Code	Pack Qty.	Bulk Qty.	Product Group	Price Each £
1/2" BSP x 20mm	49012	10	10	79M	7.56
3/4" BSP x 25mm	49034	10	10	79M	9.92
1" BSP x 32mm	4901	5	10	79M	15.06



Copper/ Polybutylene Adaptor	Code	Pack Qty.	Bulk Qty.	Product Group	Price Each £
20mm x 15mm (1/2").	47820	10	10	79M	6.54
25mm x 15mm (1/2").	4782515	10	10	79M	7.42
25mm x 22mm (3/4").	47825	10	10	79M	8.34
32mm x 22mm (3/4").	4783222	5	5	79M	16.69
32mm x 28mm (1").	47832	5	5	79M	17.53



Female Adaptor	Code	Pack Qty.	Bulk Qty.	Product Group	Price Each £
20mm x 1/2" BSP.	40320	10	100	79M	6.54
25mm x 1/2" BSP.	4032512	10	100	79M	6.77
25mm x 3/4" BSP.	40325	10	100	79M	7.16
32mm x 1" BSP.	40332	5	100	79M	9.81
40mm x 1 1/4" BSP.	40340	2	100	79M	20.31
50mm x 1 1/2" BSP.	40350	2	50	79M	26.42
63mm x 2" BSP.	40363	2	50	79M	38.05



Male Adaptor	Code	Pack Qty.	Bulk Qty.	Product Group	Price Each £
20mm x 1/2" BSP.	40420	10	150	79M	5.06
25mm x 1/2" BSP.	4042512	10	100	79M	6.54
25mm x 3/4" BSP.	40425	10	100	79M	6.64
32mm x 1" BSP.	40432	5	100	79M	10.19
40mm x 1 1/4" BSP.	40440	2	50	79M	19.08
50mm x 1 1/2" BSP.	40450	2	50	79M	24.14
63mm x 2" BSP.	40463	2	50	79M	32.55



# Water Supply

## Polyfast Polyethylene Compression Fittings

Adaptable for  
Polyethylene, Lead,  
Copper, PVC and  
Galvanised Iron



KM85017



Elbow	Code	Pack Qty.	Bulk Qty.	Product Group	Price Each £
20mm.	40120	10	100	79M	6.88
25mm.	40125	10	100	79M	10.12
32mm.	40132	5	50	79M	16.97
40mm.	40140	2	50	79M	29.19
50mm.	40150	2	20	79M	37.36
63mm.	40163	2	20	79M	49.52



Reducing Elbow	Code	Pack Qty.	Bulk Qty.	Product Group	Price Each £
25mm. 25mm x 20mm 90° Reducing.	4012520	10	10	79M	13.86



Reducing Female Elbow	Code	Pack Qty.	Bulk Qty.	Product Group	Price Each £
20mm x 1/2" BSP Female.	42120	10	100	79M	6.54
25mm x 3/4" BSP Female.	42125	10	100	79M	9.41
32mm x 1" BSP Female.	42132	5	50	79M	15.48
40mm x 1 1/4" BSP Female.	42140	2	50	79M	18.81
50mm x 1 1/2" BSP Female.	42150	2	20	79M	34.03
63mm x 2" BSP Female.	42163	2	20	79M	44.22



Tank Connector	Code	Pack Qty.	Bulk Qty.	Product Group	Price Each £
25mm x 3/4" BSP.	42525	10	150	79M	13.21



Reducing Male Elbow	Code	Pack Qty.	Bulk Qty.	Product Group	Price Each £
20mm x 1/2" BSP Male.	42320	10	100	79M	5.49
25mm x 3/4" BSP Male.	42325	10	100	79M	6.17
32mm x 1" BSP Male.	42332	10	50	79M	10.71



Equal Tee	Code	Pack Qty.	Bulk Qty.	Product Group	Price Each £
20mm.	40220	10	100	79M	9.73
25mm.	40225	10	50	79M	15.06
32mm.	40232	5	20	79M	21.10
40mm.	40240	2	20	79M	40.39
50mm.	40250	2	20	79M	47.28
63mm.	40263	1	20	79M	70.55



# Water Supply

## Polyfast Polyethylene Compression Fittings

Adaptable for  
Polyethylene, Lead,  
Copper, PVC and  
Galvanised Iron



KM85017



Branch Reducing Tee	Code	Pack Qty.	Bulk Qty.	Product Group	Price Each £
25mm x 20mm.	41125	10	100	79M	19.38
32mm x 20mm.	4113220	5	50	79M	21.84
32mm x 25mm.	41132	5	50	79M	23.40



BSP Branch Tee	Code	Pack Qty.	Bulk Qty.	Product Group	Price Each £
20mm x 1/2" BSP Female.	42220	10	100	79M	9.36
25mm x 3/4" BSP Female.	42225	10	100	79M	15.48
32mm x 1" BSP Female.	42232	5	50	79M	20.81
40mm x 1 1/4" BSP Female.	42240	2	20	79M	31.95
50mm x 1 1/2" BSP Female.	42250	2	20	79M	43.70
63mm x 2" BSP Female.	42263	1	20	79M	62.21
20mm x 1/2" BSP Male.	42420	10	100	79M	14.24
25mm x 3/4" BSP Male.	42425	10	100	79M	17.05



End Plug	Code	Pack Qty.	Bulk Qty.	Product Group	Price Each £
20mm.	40920	10	150	79M	6.64
25mm.	40925	10	150	79M	7.88
32mm.	40932	5	150	79M	10.92
40mm.	40940	2	50	79M	22.88
50mm.	40950	2	50	79M	28.19
63mm.	40963	2	50	79M	39.35



Stop End	Code	Pack Qty.	Bulk Qty.	Product Group	Price Each £
20mm.	30920	10	200	79M	1.76
25mm.	30925	10	200	79M	2.23
32mm.	30932	5	50	79M	2.62
40mm.	30940	2	50	79M	5.19
50mm.	30950	2	50	79M	5.13
63mm.	30963	2	50	79M	7.38



# Water Supply

## Polyfast Polyethylene Compression Fittings

Adaptable for  
Polyethylene, Lead,  
Copper, PVC and  
Galvanised Iron



KM85017



Plastic Pipe Stiffener 8 Bar Plastic Pipe Stiffener	Code	Pack Qty.	Bulk Qty.	Product Group	Price Each £
20mm.	46420	10	500	79M	0.65
25mm.	46425	10	500	79M	0.76
32mm.	46432	10	500	79M	0.97
40mm.	46440	10	250	79M	1.39
50mm.	46450	10	200	79M	1.47
63mm.	46463	10	100	79M	1.67
50mm. 8 Bar Stiffener.	47450	10	10	79M	1.71
63mm. 8 Bar Stiffener.	47463	10	10	79M	1.99



MDPE High Flow Reducing Set	Code	Pack Qty.	Bulk Qty.	Product Group	Price Each £
25mm x 20mm.	4802520	10	10	79M	4.13
32mm x 20mm.	4803220	5	5	79M	5.60
32mm x 25mm.	4803225	5	5	79M	5.60
50mm x 20mm.	4805020	5	5	79M	11.42
50mm x 25mm.	4805025	5	5	79M	11.42
50mm x 32mm.	4805032	5	5	79M	11.42
63mm x 20mm.	4806320	5	5	79M	17.05
63mm x 25mm.	4806325	5	5	79M	17.05
63mm x 32mm.	4806332	5	5	79M	17.05
63mm x 50mm.	4806350	5	5	79M	17.05



MDPE Reducing Set	Code	Pack Qty.	Bulk Qty.	Product Group	Price Each £
25mm x 20mm.	4712520	10	10	79M	4.13
32mm x 20mm.	4713220	5	5	79M	5.60
32mm x 25mm.	4713225	5	5	79M	5.60
50mm x 20mm.	4715020	5	5	79M	11.42
50mm x 25mm.	4715025	5	5	79M	11.42
50mm x 32mm.	4715032	5	5	79M	11.42
63mm x 20mm.	4716320	5	5	79M	17.05
63mm x 25mm.	4716325	5	5	79M	17.05
63mm x 32mm.	4716332	5	5	79M	17.05
63mm x 50mm.	4716350	5	5	79M	17.05



# Water Supply

## Polyfast Polyethylene Compression Fittings

Adaptable for  
Polyethylene, Lead,  
Copper, PVC and  
Galvanised Iron



KM85017



Copper Adaptor Set	Code	Pack Qty.	Bulk Qty.	Product Group	Price Each £
20mm x 15mm Cu.	46820	10	250	79M	3.80
25mm x 15mm Cu.	4682515	10	250	79M	5.60
25mm x 22mm Cu.	46825	10	250	79M	4.70
32mm x 28mm Cu.	46832	5	250	79M	6.85



Lead Adaptor Set	Code	Pack Qty.	Bulk Qty.	Product Group	Price Each £
20mm x 3/8" 5lb.	46920	10	250	79M	2.32
25mm x 1/2" 7lb.	46925	10	250	79M	2.62
25mm x 3/4" 9lb.	46932	5	200	79M	3.04
32mm x 3/4" 11lb.	469329	5	100	79M	3.04
40mm x 1" 16lb.	46940	2	100	79M	6.39



Wider Tolerance Lead Coupler	Code	Pack Qty.	Bulk Qty.	Product Group	Price Each £
25mm x 3/8" 5lb.	479385	10	10	79M	9.98
25mm x 1/2" 7lb.	479127	10	10	79M	9.50
25mm x 1/2" 9lb.	479129	10	10	79M	11.28
25mm x 3/4" 9lb.	479349	10	10	79M	15.86
32mm x 3/4" 11lb.	4793411	5	10	79M	29.32
32mm x 1" 16lb.	479116	5	10	79M	38.89



Mid Blue Polyethylene Adaptor Set	Code	Pack Qty.	Bulk Qty.	Product Group	Price Each £
20mm x 1/2".	465C12	10	250	79M	1.44
25mm x 3/4".	465C34	10	250	79M	1.74
32mm x 1".	465C1	10	150	79M	1.91
50mm. 50mm x 1 1/4".	465C114	2	150	79M	3.35
50mm. 50mm x 1 1/2".	465C112	2	100	79M	4.53
63mm. 63mm x 2".	465C2	2	100	79M	6.85

Low Density BS1972:1967 Class C. To connect 3/8" use 1/2" 467NG12 with 20mm Nut and Body



Light Green Polyethylene Adaptor Set	Code	Pack Qty.	Bulk Qty.	Product Group	Price Each £
25mm x 1/2".	465D12	10	250	79M	1.26
25mm x 3/4".	465D34	10	250	79M	1.74
32mm x 1".	465D1	10	250	79M	1.76
50mm x 1 1/4".	465D114	2	150	79M	3.35
50mm x 1 1/2".	465D112	2	100	79M	4.53

Low Density BS1972:1967 Class D



# Water Supply

## Polyfast Polyethylene Compression Fittings

Adaptable for  
Polyethylene, Lead,  
Copper, PVC and  
Galvanised Iron



KM85017



Dark Blue Polyethylene Adaptor Set	Code	Pack Qty.	Bulk Qty.	Product Group	Price Each £
20mm x 1/2".	466C12	10	250	79M	1.13
25mm x 3/4".	466C34	10	250	79M	1.44
32mm x 1".	466C1	10	250	79M	1.54
50mm x 1 1/4".	466C114	2	150	79M	3.35
50mm x 1 1/2".	466C112	2	100	79M	4.53
63mm x 2".	466C2	2	80	79M	6.85



Dark Green Polyethylene Adaptor Set	Code	Pack Qty.	Bulk Qty.	Product Group	Price Each £
20mm x 3/8".	466D38	10	250	79M	1.85
20mm x 1/2".	466D12	10	250	79M	1.19
25mm x 3/4".	466D34	10	250	79M	1.44
32mm x 1".	466D1	10	200	79M	1.76
50mm x 1 1/4".	466D114	2	100	79M	3.35
50mm x 1 1/2".	466D112	2	100	79M	4.53
63mm x 2".	466D2	2	80	79M	6.85



Red Polyethylene Adaptor Set	Code	Pack Qty.	Bulk Qty.	Product Group	Price Each £
20mm x 1/2".	467NG12	10	10	79M	1.57
25mm x 3/4".	467NG34	10	10	79M	2.18
32mm x 1".	467NG1	10	10	79M	2.32
50mm x 1 1/4".	467NG114	2	2	79M	5.06
50mm x 1 1/2".	467NG112	2	2	79M	5.89
63mm x 2".	467NG2	2	2	79M	9.53



Light Blue Polyethylene Adaptor Set	Code	Pack Qty.	Bulk Qty.	Product Group	Price Each £
20mm x 1/2".	467HG12	10	250	79M	1.57
25mm x 3/4".	467HG34	10	250	79M	1.89
32mm x 1".	467HG1	10	250	79M	2.32
50mm x 1 1/4".	467HG114	2	150	79M	5.06
50mm x 1 1/2".	467HG112	2	150	79M	5.89



PVC BS3506/6 Galvanised Iron BS1387	Code	Pack Qty.	Bulk Qty.	Product Group	Price Each £
20mm x 3/8".	4722038	10	10	79M	3.80
25mm x 1/2".	4722512	10	10	79M	5.32
32mm x 3/4".	4723234	10	10	79M	6.39
40mm x 1".	47240	5	10	79M	9.67



# Water Supply

## Polyfast Polyethylene Compression Fittings

Adaptable for  
Polyethylene, Lead,  
Copper, PVC and  
Galvanised Iron





KM85017





Bibtap Wall Flange (DZR Brass)	Code	Pack Qty.	Bulk Qty.	Product Group	Price Each £	
20mm x 1/2" BSP.	41320	2	10	79M	24.47	
25mm x 1/2" BSP.	41325	2	10	79M	30.40	
25mm x 3/4" BSP.	4132534	2	10	79M	29.32	

Bibtap Wall Flange (Plastic)	Code	Pack Qty.	Bulk Qty.	Product Group	Price Each £	
20mm x 1/2" BSP.	48320	2	10	79M	11.91	
25mm x 1/2" BSP.	4832512	2	10	79M	12.18	
25mm x 3/4" BSP.	48325	2	10	79M	14.72	

Gunmetal Stop Cock - Polyfast Ends	Code	Pack Qty.	Bulk Qty.	Product Group	Price Each £	
20mm.	41020	2	10	79M	61.86	
25mm.	41025	2	10	79M	84.67	
32mm.	41032	1	10	79M	147.27	

Gunmetal Stop Cock - Female Iron	Code	Pack Qty.	Bulk Qty.	Product Group	Price Each £	
1 1/2" F.I. - requires adaptors	31050	1	1	79M	279.22	
2" F.I. - requires adaptors	31063	1	1	79M	411.24	

Engineering Plastic Stop Cock (complete with excess torque override feature)	Code	Pack Qty.	Bulk Qty.	Product Group	Price Each £	
20mm.	42620	2	50	79M	31.41	
25mm.	42625	2	50	79M	46.44	
32mm.	42632	1	10	79M	76.17	

Square Drive Stop Cock (Engineering Plastic)	Code	Pack Qty.	Bulk Qty.	Product Group	Price Each £	
20mm.	49120	2	10	79M	31.41	
25mm.	49125	2	10	79M	46.44	

Stop Cock	Code	Pack Qty.	Bulk Qty.	Product Group	Price Each £	
20mm x 15mm (1/2") Copper.	47720	2	50	79M	31.85	
25mm x 15mm (1/2") Copper.	4772515	2	50	79M	32.37	
25mm x 22mm (3/4") Copper.	47725	2	50	79M	41.47	



# Water Supply

## Polyfast Polyethylene Compression Fittings

Adaptable for  
Polyethylene, Lead,  
Copper, PVC and  
Galvanised Iron



KM85017



Double Check Valve	Code	Pack Qty.	Bulk Qty.	Product Group	Price Each £
20mm.	47620	1	100	79M	44.38
25mm.	47625	1	50	79M	48.28
32mm.	47632	1	50	79M	66.01



Single Union Ball Valve	Code	Pack Qty.	Bulk Qty.	Product Group	Price Each £
½" F.I.	47312	2	10	79M	25.89
¾" F.I.	47334	2	10	79M	28.67
1" F.I.	4731	2	10	79M	34.54



Threaded Reducing Bush	Code	Pack Qty.	Bulk Qty.	Product Group	Price Each £
¾" x ½" BSP.	4703412	10	10	79M	5.52
1" x ½" BSP.	470112	10	10	79M	9.00
1" x ¾" BSP.	470134	10	10	79M	9.00
1¼" x 1" BSP.	4701141	5	10	79M	9.46
1½" x ½" BSP.	47011212	5	10	79M	5.96
1½" x ¾" BSP.	47011234	5	10	79M	9.46
1½" x 1" BSP.	4701121	5	10	79M	5.96
1½" x 1¼" BSP.	470112114	2	10	79M	5.96
2" x ½" BSP.	470212	2	10	79M	9.22
2" x ¾" BSP.	470234	2	10	79M	9.22
2" x 1" BSP.	47021	2	10	79M	9.22
2" x 1½" BSP.	4702112	2	10	79M	9.22
3" x 2" BSP.	47032	1	10	79M	18.10
4" x 3" BSP.	47043	1	10	79M	18.31



Spigot Reducer	Code	Pack Qty.	Bulk Qty.	Product Group	Price Each £
50mm x 20mm.	3085020			79M	12.75
50mm x 25mm.	3085025			79M	12.75
50mm x 32mm.	3085032			79M	12.75
63mm x 20mm.	3086320			79M	15.28
63mm x 25mm.	3086325			79M	15.28
63mm x 32mm.	3086332			79M	15.28



# Water Supply

## Polyguard Barrier Pipe & Fittings



- Conforms with Type A: WIS 4-32-19: Polyethylene pressure pipe systems with an aluminium barrier layer for potable water supply in contaminated land
- Complies with BS6920 Water Quality Testing
- Approved under regulation 31 of the Water Supply (Water Quality) Regulations 2000
- "Approved for use in public water supplies"
- WIS approval for plastic fittings for Polyguard Barrier Pipe providing manufacturer's instructions are followed upon installation.

Polyguard Barrier Pipe	Code	Pack Qty.	Bulk Qty.	Product Group	Price Each £
25mm. Polyguard pipe x 50m coil.	PGP2550	1	1	119E	681.09
32mm. Polyguard pipe x 50m coil.	PGP3250	1	1	119E	879.83
63mm. Polyguard pipe x 6m length.	PGP636	1	1	119E	288.87
63mm. Polyguard pipe x 25m coil.	PGP6325	1	1	119E	1,203.58
63mm. Polyguard pipe x 50m coil.	PGP6350	1	1	119E	2,407.15



Polyguard Plastic Fittings	Code	Pack Qty.	Bulk Qty.	Product Group	Price Each £
25mm Coupler.	PGF40025	1	10	119M	11.85
32mm Coupler.	PGF40032	1	10	119M	19.34
32 x 25mm Reducer.	PGF40632	1	10	119M	25.60
25mm x 3/4" Male Adaptor.	PGF40425	1	10	119M	8.89
32mm x 1" Male Adaptor.	PGF40432	1	10	119M	13.19
25mm x 3/4" Female Adaptor.	PGF40325	1	10	119M	9.79
32mm x 1" Female Adaptor.	PGF40332	1	10	119M	12.67
25mm Elbow.	PGF40125	1	10	119M	14.43
32mm Elbow.	PGF40132	1	10	119M	22.12
25mm Tee.	PGF40225	1	10	119M	21.88
32mm Tee.	PGF40232	1	10	119M	28.52
25mm x 15mm Transition Coupler.	PGF4782515	1	10	119M	13.35
25mm x 22mm Transition Coupler.	PGF47825	1	10	119M	14.54
32mm x 28mm Transition Coupler.	PGF47832	1	10	119M	22.83
25mm Polyguard x 25mm MDPE Transition Coupler.	PGF402525	1	10	119M	9.56
32mm Polyguard x 32mm MDPE Transition Coupler.	PGF403232	1	10	119M	17.53
25mm Stopcock. Gun Metal Body.	PGF41025	1	10	119M	102.19
32mm Stopcock. Gun Metal Body.	PGF41032	1	10	119M	171.55
25mm Endcap.	PGF40925	1	10	119M	13.03
32mm Endcap.	PGF40932	1	10	119M	21.27



PGF40032



PGF40432



PGF40932

# Water Supply

## Polyguard Barrier Pipe & Fittings

- Conforms with Type A: WIS 4-32-19: Polyethylene pressure pipe systems with an aluminium barrier layer for potable water supply in contaminated land
- Complies with BS6920 Water Quality Testing
- Approved under regulation 31 of the Water Supply (Water Quality) Regulations 2000
- "Approved for use in public water supplies"
- WIS approval for plastic fittings for Polyguard Barrier Pipe providing manufacturer's instructions are followed upon installation.

Polyguard DZR Gunmetal Fittings	Code	Pack Qty.	Bulk Qty.	Product Group	Price Each £
25mm. Polyguard straight coupling.	PGF25SC	1	10	119M	35.17
32mm. Polyguard straight coupling.	PGF32SC	1	10	119M	50.76
63mm. Polyguard straight coupling.	PGF63SC	1	10	119M	136.44
25mm. Polyguard x 3/4" MBSP coupling.	PGF25MTC	1	10	119M	17.50
32mm. Polyguard x 1" MBSP coupling.	PGF32MTC	1	10	119M	27.83
63mm. Polyguard x 2" MBSP coupling.	PGF63MTC	1	10	119M	109.88
25mm. Polyguard x 3/4" FBSP coupling.	PGF25FTC	1	10	119M	17.50
32mm. Polyguard x 1" FBSP coupling.	PGF32FTC	1	10	119M	27.83
63mm. Polyguard x 2" FBSP coupling.	PGF63FTC	1	10	119M	81.85
25mm. Polyguard 90° elbow.	PGF2590E	1	10	119M	52.37
32mm. Polyguard 90° elbow.	PGF3290E	1	10	119M	108.62
63mm. Polyguard 90° elbow.	PGF6390E	1	10	119M	242.87
25mm. Polyguard equal tee.	PGF25T	1	10	119M	93.71
32mm. Polyguard equal tee.	PGF32T	1	10	119M	144.61
63mm. Polyguard equal tee.	PGF63T	1	10	119M	316.59
25mm x 15mm. Polyguard to copper transition coupling.	PGF2515TC	1	10	119M	55.61
25mm x 22mm. Polyguard to copper transition coupling.	PGF2522TC	1	10	119M	64.74
25mm x 25mm. Polyguard to PE transition coupling.	PGF2525TC	1	10	119M	30.36
32mm x 32mm. Polyguard to PE transition coupling.	PGF3232TC	1	10	119M	45.48
63mm x 63mm. Polyguard to PE transition coupling.	PGF6363TC	1	10	119M	107.97



PGF32SC



PGF3290E

# Water Supply

## Water Supply Pipe and Fittings Ancillaries

 Polypipe

Pipe Cutter	Code	Pack Qty.	Bulk Qty.	Product Group	Price Each £	
20mm to 25mm.	PB781	1	10	123M	24.80	

Pipe Cutter (Ratchet)	Code	Pack Qty.	Bulk Qty.	Product Group	Price Each £	
20mm to 32mm.	PB778	1	10	123M	37.62	

MDPE PE80 Yellow Gas Pipe	Code	Pack Qty.	Bulk Qty.	Product Group	Price Each £
20mm x 50mm Coil - SDR 9 - 5.5 MOP Bar.	2050YE	1	10	75E	POA
20mm x 100mm Coil - SDR 9 - 5.5 MOP Bar.	20100YE	1	6	75E	POA
25mm x 6m Length - SDR 11 - 5.5 MOP Bar.	2506YE	1	200	75E	POA
25mm x 50m Coil - SDR 11 - 5.5 MOP Bar.	2550YE	1	7	75E	POA
25mm x 100m Coil - SDR 11 - 5.5 MOP Bar.	25100YE	1	6	75E	POA
32mm x 6m Length - SDR 11 - 5.5 MOP Bar.	3206YE	1	150	75E	POA
32mm x 50m Coil - SDR 11 - 5.5 MOP Bar.	3250YE	1	6	75E	POA
32mm x 100m Coil - SDR 11 - 5.5 MOP Bar.	32100YE	1	5	75E	POA
63mm x 6m Length - SDR 11 - 5.5 MOP Bar.	630611YE	1	100	75E	POA
63mm x 50m Coil - SDR 11 - 5.5 MOP Bar.	635011YE	1	2	75E	POA
63mm x 100m Coil - SDR 11 - 5.5 MOP Bar.	6310011YE	1	2	75E	POA
75mm x 6m Length - SDR 11 - 5.5 MOP Bar.	750611YE	1	64	75E	POA
75mm x 120m Coil - SDR 11 - 5.5 MOP Bar.	7512011YE	1	1	75E	POA



Other diameter and length combinations are available to order.  
Please contact the sales office for further information.

All combinations are compatible with UK Gas industry approved electrofusion fittings.

# Geothermal Systems

For use with Ground Source Heat Pumps

EN12201-2 For use with Ground Source Heat Pumps Black MDPE PE80 SDR 11. For all fitting requirements please use Polyfast Compression fittings Pages 40 to 48

 **Polypipe**

Geothermal Pipe	Code	Pack Qty.	Colour	Product Group	Price Each £
32mm. 100m Coil.	32100G	1	ⓑ	73E	475.30
32mm. 250m Coil.	32250G	1	ⓑ	73E	1,188.30
32mm. 300m Coil.	32300G	1	ⓑ	73E	1,425.91
32mm. 400m Coil.	32400G	1	ⓑ	73E	1,901.21
40mm. 100m Coil.	40100G	1	ⓑ	73E	739.21
40mm. 250m Coil.	40250G	1	ⓑ	73E	1,848.26
40mm. 300m Coil.	40300G	1	ⓑ	73E	2,217.62
40mm. 400m Coil.	40400G	1	ⓑ	73E	2,956.81



# Pre-Insulated Pipes

For the distribution of hot and cold water and for heating

Pre-Insulated Pipes	Code	Pack Qty.	Colour	Product Group	Price Each £
25mm. 10m Twin Pipe Coil PE-Xa 2mm x 25mm (OD) 20DN (ID).	INS1025-2-HTG	1		184E	398.34
25mm. 15m Twin Pipe Coil PE-Xa 2mm x 25mm (OD) 20DN (ID).	INS1525-2-HTG	1		184E	597.53
25mm. 20m Twin Pipe Coil PE-Xa 2mm x 25mm (OD) 20DN (ID).	INS2025-2-HTG	1		184E	796.68
32mm. 10m Twin Pipe Coil PE-Xa 2mm x 32mm (OD) 25DN (ID).	INS1032-2-HTG	1		184E	469.29
32mm. 15m Twin Pipe Coil PE-Xa 2mm x 32mm (OD) 25DN (ID).	INS1532-2-HTG	1		184E	703.95
32mm. 20m Twin Pipe Coil PE-Xa 2mm x 32mm (OD) 25DN (ID).	INS2032-2-HTG	1		184E	938.60



Dust Cap	Code	Pack Qty.	Colour	Product Group	Price Each £
160mm x 25mm Dust Cap	INS160-25-ZDC	1		185M	10.20
160mm x 32mm Dust Cap	INS160-32-ZDC	1		185M	10.20



Heat Shrink Cap	Code	Pack Qty.	Colour	Product Group	Price Each £
160mm Heat Shrink Cap.	INS160-3225-2HSC	1		185M	102.54



Insulation Kit <small>For Coupler</small>	Code	Pack Qty.	Colour	Product Group	Price Each £
160mm Insulation Kit for Coupler	INS160IKC	1		185M	83.06



Male Couplings <small>For PEX pipe</small>	Code	Pack Qty.	Colour	Product Group	Price Each £
25mm (OD)/2.3 (w/t) thread ¾"	INS25MC-HTG	1		185M	24.27
32mm (OD)/2.9 (w/t) thread 1"	INS32MC-HTG	1		185M	31.82



Female Couplings	Code	Pack Qty.	Colour	Product Group	Price Each £
25mm, thread ¾"	INS25FC-HTG	1		185M	4.73
32mm, thread 1"	INS32FC-HTG	1		185M	6.95



Fix Points	Code	Pack Qty.	Colour	Product Group	Price Each £
25mm, thread ¾" FF	INS25FP-HTG	1		185M	8.55
32mm, thread 1" FF	INS32FP-HTG	1		185M	19.43





Max operating pressure: 6 bar.  
Max fluid temperature: +95°C.  
PE-Xa pipes: SDR 11.

Carrier pipes are individually identified as flow and return.

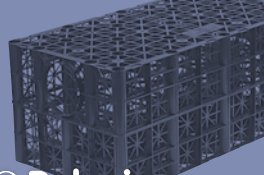

Polystorm-R Modular Water Storage Unit	Code	Pack Qty.	Bulk Qty.	Product Group	Price Each £	
1000mm Long x 500mm Wide x 400mm High 61 Tonnes Loading per sq metre 95% Void Ratio, 9kg Supplied with 4 Clips & 2 Shear connectors For use in trafficked and pedestrian applications (subject to a structural design check and suitable installation conditions).	PSM1A	1	15		POA	
Polystorm Lite Modular Water Storage Unit	Code	Pack Qty.	Bulk Qty.	Product Group	Price Each £	
1000mm Long x 500mm Wide x 400mm High 20 Tonnes Loading per sq metre 95% Void Ratio, 7kg Supplied with 4 Clips & 2 Shear connectors Designed for landscaped, pedestrians or other non-loaded applications.	PSM2	1	15		POA	
Polystorm Xtra Modular Water Storage Unit	Code	Pack Qty.	Bulk Qty.	Product Group	Price Each £	
1000mm Long x 500mm Wide x 210mm High 80 Tonnes Loading per sq metre 94% Void Ratio, 6kg, Supplied with 4 Clips & 2 Shear connectors. Designed for heavy trafficked conditions which require shallow excavations or deep burial depths. Half Size.	PSM3	1	30		POA	
Polystorm Inspect	Code	Pack Qty.	Bulk Qty.	Product Group	Price Each £	
1000mm Long x 500mm Wide x 400mm High 44 Tonnes Loading per sq metre 94% Void Ratio, 11.6kg Its primary purpose is to provide a tunnel along the length of a fully installed Polystorm structure to enable access for inspection and maintenance.	PSM4	1	15		POA	
Polystorm Deep Modular Water Storage Unit	Code	Pack Qty.	Bulk Qty.	Product Group	Price Each £	
1000mm Long x 500mm Wide x 400mm High 61 Tonnes Vertical Loading per sq metre, 14.6 Tonnes Horizontal Loading per sq metre, 95% Void Ratio, 9kg Supplied with 4 Clips & 2 Shear connectors For deeper burial depths. Can be used below Polystorm-R to create a hybrid system for deeper installation.	PSM5 	1	15		POA	







Polystorm Access	Code	Pack Qty.	Bulk Qty.	Product Group	Price Each £	
Polystorm Access provides a 1m x 0.5m shaft within a Polystorm geocellular structure to enable surface access for remote camera inspection and maintenance activities such as flushing and rodding.	PSMACCESS				POA	

Polypoak Pre-wrapped Soakaway Unit	Code	Pack Qty.	Bulk Qty.	Product Group	Price Each £	
1000mm Long x 500mm Wide x 800mm High 2 PSM1As pre-wrapped in a geotextile.	POLYSOAK	1	4	173M	POA	

Polystorm Accessories	Code	Pack Qty.	Bulk Qty.	Product Group	Price Each £	
Brick Bond connector.	PSMBBSC	1	30	170M	3.23	 PSMCLIP  PSMSC
Spare Polystorm clips.	PSMCLIP	1	60	170M	2.27	
Spare Polystorm shear connectors.	PSMSC	1	30	170M	1.87	
150mm Ridgidrain flange adaptor.	PSMFA150	1		170M	105.65	
110mm EN1401-1 flange adaptor.	PSMFA110	1		170M	68.33	
160mm EN1401-1 flange adaptor.	PSMFA160	1		170M	112.89	

Underground Drainage Accessories	Code	Pack Qty.	Bulk Qty.	Product Group	Price Each £	
100mm Ridgidrain socket x 110mm EN1401-1 Spigot Adaptor.	ARD100110	1		167E	41.81	 UG621
160mm x 110mm single socket level invert reducer.	UG621	1		51M	46.35	
150mm Ridgidrain socket x 160mm EN1401-1 Spigot Adaptor.	ARD150160	1		167E	71.34	

Basic Silt Trap	Code	Pack Qty.	Bulk Qty.	Product Group	Price Each £	
Adjustable sump level and height to cover (risers and seals required), 160mm inlet and outlet 460mm dia. x 1220mm deep.	PSMST160	1			POA	

Advanced Silt Trap	Code	Pack Qty.	Bulk Qty.	Product Group	Price Each £	
Stainless steel silt bucket for larger objects, secondary filtration for smaller particles Bucket and filter easily removed for cleaning. For use where invert level does not exceed 1.2m 15 litres per second max flow rate. 160mm inlet and outlet. 460mm dia. x 830mm deep.	*PSMSTA160/15	1			POA	

\*PSMSTA160/15 is made to order, allow 14 days

Mini Silt Trap	Code	Pack Qty.	Bulk Qty.	Product Group	Price Each £	
320mm dia x 440mm height, 110mm inlet and outlet Silt bucket included, max burial depth 1m. can be used with UG438 or UG466 side riser and UG439 cover & frame	PSMST110	1			POA	

Silt Trap Accessories	Code	Pack Qty.	Bulk Qty.	Product Group	Price Each £	
Round Polypropylene Screw down cover & frame BS7158 [A+].	UG511	1		51M	124.82	UG510
460mm. Square Cover and 65mm Deep Frame Polypropylene [A+]. Complete with cover to frame O ring seal and fixing screws with 350mm restricted access (removable) for depths greater than 1.2metres.	UG510 <b>NEW</b>	1	5	51M	161.89	
460mm. Frame to Riser seal for UG510 Square Cover and Frame	UG515 <b>NEW</b>	1		51M	8.15	
Silt Trap side riser (215mm effective height).	ICDR1	1		51M	78.94	
Silt Trap sealing ring.	UG488	1		51M	7.50	

Flow Control Unit	Code	Pack Qty.	Bulk Qty.	Product Group	Price Each £	
460mm dia x 1200mm high, 2 x 110mm inlet, 1 x 110mm outlet, 160mm Overflow. Max burial depth 1.2m. Suitable for 400mm deep Polystorm Storage Structures only.	*PSMFC160/30	1			POA	

\*PSMFC160/30 is made to order, allow 14 days



Rainstream Home Tanks	Code	Pack Qty.	Bulk Qty.	Product Group	Price Each £
Rainstream Home Below Ground Tank 1,000lts complete with component kit including filter. (2/3 weeks delivery time).	RWH.RH.BGT.1			176M	1,571.77
Rainstream Home Below Ground Tank 2,000lts complete with component kit including filter. (2/3 weeks delivery time).	RWH.RH.BGT.2			176M	1,910.82
Rainstream Home Below Ground Tank 3,000lts complete with component kit including filter. (2/3 weeks delivery time).	RWH.RH.BGT.3			176M	2,352.80
Rainstream Home Below Ground Tank 4,000lts complete with component kit including filter. (3/4 weeks delivery time).	RWH.RH.BGT.4			176M	2,882.75
Rainstream Home Below Ground Tank 5,000lts complete with component kit including filter. (3/4 weeks delivery time).	RWH.RH.BGT.5			176M	3,196.10
Rainstream Home Below Ground Tank 7,500lts complete with component kit including filter. (3/4 weeks delivery time).	RWH.RH.BGT.7.5			176M	5,107.41
Rainstream Home Below Ground Tank 10,000lts complete with component kit including filter. (3/4 weeks delivery time).	RWH.RH.BGT.10			176M	6,058.55



Rainstream tanks require a pump pack and connection set (Page 62) for a full installation.

Rainstream Home Tanks with Ground Water Inlet Valves	Code	Pack Qty.	Bulk Qty.	Product Group	Price Each £	
Rainstream Home Below Ground Tank 1,000lts complete with component kit including filter and ground water inlet valve. (2/3 weeks delivery time).	RWH.RH.BGTV.1			176M	1,757.46	
Rainstream Home Below Ground Tank 2,000lts complete with component kit including filter and ground water inlet valves. (2/3 weeks delivery time).	RWH.RH.BGTV.2			176M	2,282.20	
Rainstream Home Below Ground Tank 3,000lts complete with component kit including filter and ground water inlet valves. (2/3 weeks delivery time).	RWH.RH.BGTV.3			176M	2,724.18	
Rainstream Home Below Ground Tank 4,000lts complete with component kit including filter and ground water inlet valves. (3/4 weeks delivery time).	RWH.RH.BGTV.4			176M	3,254.13	
Rainstream Home Below Ground Tank 5,000lts complete with component kit including filter and ground water inlet valves. (3/4 weeks delivery time).	RWH.RH.BGTV.5			176M	3,567.49	Water Inlet Valve
Rainstream Home Below Ground Tank 7,500lts complete with component kit including filter and ground water inlet valves. (3/4 weeks delivery time).	RWH.RH.BGTV.7.5			176M	5,478.81	
Rainstream Home Below Ground Tank 10,000lts complete with component kit including filter and ground water inlet valves. (3/4 weeks delivery time).	RWH.RH.BGTV.10			176M	6,429.93	

Rainstream tanks require a pump pack and connection set (Page 62) for a full installation.

Standard Turrett Extension	Code	Pack Qty.	Bulk Qty.	Product Group	Price Each £	
Rainstream Home Below Ground Tank Standard Turrett Extension 570mm.	RWH.RH.A.TE			176M	222.54	
Small Turrett Extension	Code	Pack Qty.	Bulk Qty.	Product Group	Price Each £	
Rainstream Home Below Ground Tank Small Turrett Extension 150mm.	RWH.RH.A.TE2			176M	141.35	
Reinforced Cover & Frame	Code	Pack Qty.	Bulk Qty.	Product Group	Price Each £	
Rainstream Home Reinforced Cover and Frame (600kg wheel loading).	RWH.RH.A.RC			176M	560.54	

Pump Pack 1	Code	Pack Qty.	Bulk Qty.	Product Group	Price Each £	
Rainstream Home direct pressure system 1,000ltr tank RWH.RH.CSCS.P.HOME must be ordered with this item.	RWH.RH.PP.1000			176M	1,198.26	
Pump Pack 2	Code	Pack Qty.	Bulk Qty.	Product Group	Price Each £	
Rainstream Home Indirect gravity system 1,000ltr tank RWH.RH.CSCS.G.HOME must be ordered with this item.	RWH.RH.PG.1000			176M	1,318.10	
Pump Pack 3	Code	Pack Qty.	Bulk Qty.	Product Group	Price Each £	
Rainstream Home Direct pressure system 15mtr RWH.RH.CSCS.P.HOME must be ordered with this item.	RWH.RH.PP.15			176M	1,623.15	
Pump Pack 4	Code	Pack Qty.	Bulk Qty.	Product Group	Price Each £	
Rainstream Home Direct pressure system 25mtr WH.RH.CSCS.P.HOME must be ordered with this item.	RWH.RH.PP.25			176M	1,704.31	
Pump Pack 5	Code	Pack Qty.	Bulk Qty.	Product Group	Price Each £	
Rainstream Home Indirect gravity system 15mtr RWH.RH.CSCS.G.HOME must be ordered with this item.	RWH.RH.PG.15			176M	1,651.56	
Pump Pack 6	Code	Pack Qty.	Bulk Qty.	Product Group	Price Each £	
Rainstream Home Indirect gravity system 25mtr RWH.RH.CSCS.G.HOME must be ordered with this item.	RWH.RH.PG.25			176M	1,734.15	
Rainstream Garden System for Garden Irrigation only (All components required)	Code	Pack Qty.	Bulk Qty.	Product Group	Price Each £	
Rainstream Home Below Ground Tank 1,000lts complete with component kit including filter. (2/3 weeks delivery time).	RWH.RH.BGT.1	1		176M	1,571.77	
Rainstream Garden system pack.	RWH.RH.PG.G	1		176M	666.67	
Rainstream Garden system connection pack Reclaimed Rainwater Supply Pipe Included.	RWH.RH.CSCS.RG	1		176M	127.28	

Connection Sets	Code	Pack Qty.	Bulk Qty.	Product Group	Price Each £
Direct Pressurised System connection pack Reclaimed Rainwater Supply Pipe Included.	RWH.RH.CSCS.P.HOME			176M	301.16
Indirect Gravity System connection pack Reclaimed Rainwater Supply Pipe Included.	RWH.RH.CSCS.G.HOME			176M	152.18

Reclaimed Rainwater Supply Pipes	Code	Pack Qty.	Bulk Qty.	Product Group	Price Each £
25mm x 25m . WRAS rainwater supply pipe 25mm diameter x 25mts coil length.	RWH.GA.RWP25.25			171E	92.81
32mm x 25m. WRAS rainwater supply pipe 32mm diameter x 25mts coil length.	RWH.GA.RWP32.25			171E	155.56



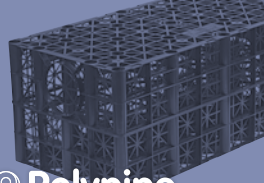



6m Single Socket PVCu General Purpose Duct	Code	Pack Qty.	Bulk Qty.	Product Group	Price Each £
2"/54mm. Nominal OD: 54mm, Nominal ID: 51.0mm.	DUCT 2A	1	400	62E	16.88
3"/90mm. Nominal OD: 88.9mm, Nominal ID: 85.0mm.	DUCT 3	1	144	62E	24.69
4"/114.8mm. Nominal OD: 114.3mm, Nominal ID: 110.4mm.	DUCT 4B	1	86	62E	28.31
6"/168mm. Nominal OD: 168.3mm, Nominal ID: 162.9mm.	DUCT 6B	1	36	62E	51.49



Duct Couplings	Code	Pack Qty.	Bulk Qty.	Product Group	Price Each £
54mm.	DUCT 2AC	1		63M	3.93
90mm.	DUCT 3C	1		63M	5.93
114mm.	DUCT 4BC	1		63M	6.58
168mm.	DUCT 6BC	1		63M	7.26





90° Duct Bend Single Socket	Code	Pack Qty.	Bulk Qty.	Product Group	Price Each £
54mm.	DUCT 2AX90	1		63M	8.92
90mm.	DUCT 3X90	1		63M	9.92
114mm.	DUCT 4BX90	1		63M	12.34
168mm.	DUCT 6BX90	1		63M	28.63



45° Duct Bend Single Socket	Code	Pack Qty.	Bulk Qty.	Product Group	Price Each £
54mm.	DUCT 2AX45	1		63M	8.92
90mm.	DUCT 3X45	1		63M	9.92
114mm.	DUCT 4BX45	1		63M	12.34
168mm.	DUCT 6BX45	1		63M	28.63

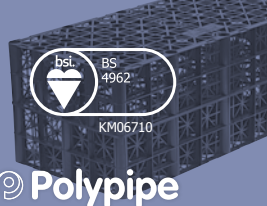



Coiled Perforated Land Drainage Pipe	Code	Pack Qty.	Bulk Qty.	Product Group	Price Each £	
60mm x 25m Coil. Nominal ID: 50.0mm.	LD6025B	1		60E	55.23	
60mm x 50m Coil. Nominal ID: 50.0mm.	LD6050B	1		60E	110.37	
60mm x 150m Coil. Nominal ID: 50.0mm.	LD60150B	1		60E	294.16	
80mm x 25m Coil. Nominal ID: 70.5mm.	LD8025B	1		60E	82.82	
80mm x 50m Coil. Nominal ID: 70.5mm.	LD8050B	1		60E	165.67	
80mm x 100m Coil. Nominal ID: 70.5mm.	LD80100B	1		60E	294.13	
100mm x 25m Coil. Nominal ID: 90.0mm.	LD10025B	1		60E	145.92	
100mm x 50m Coil. Nominal ID: 90.0mm.	LD10050B	1		60E	291.83	
100mm x 100m Coil. Nominal ID: 90.0mm.	LD100100B	1		60E	518.22	
160mm x 25m Coil. Nominal ID: 150.0mm.	LD16025B	1		60E	363.62	
160mm x 45m Coil. Nominal ID: 150.0mm.	LD16045B	1		60E	619.21	

  

Land Drainage Coupler	Code	Pack Qty.	Bulk Qty.	Product Group	Price Each £	
60mm.	HCC60	1		61M	4.46	
80mm.	HCC80	1		61M	4.98	
100mm.	HCC100	1		61M	5.60	
160mm.	HCC160	1		61M	6.34	

Multi Y Junction	Code	Pack Qty.	Bulk Qty.	Product Group	Price Each £	
80 x 100mm. (Do Not Solvent Weld Polypropylene).	CDJ10M	1		61M	14.73	
160mm. (Do Not Solvent Weld Polypropylene).	CDJ160M	1		61M	28.23	



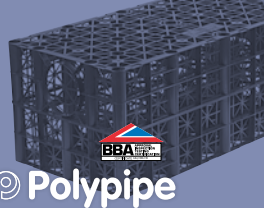

Solid Ridgidrain	Code	Pack Qty.	Bulk Qty.	Product Group	Price Each £
150mm. x 6m Plain Ended.	RD150X6PE/1	1		167E	35.63
225mm. x 6m Plain Ended.	RD225X6PE/1	1		167E	88.83
300mm. x 6m Plain Ended.	RD300X6PE/1	1		167E	138.09



Perf Ridgidrain	Code	Pack Qty.	Bulk Qty.	Product Group	Price Each £
150mm. x 6m Plain Ended.	RD150X6PEP/1	1		167E	37.37
225mm. x 6m Plain Ended.	RD225X6PEP/1	1		167E	93.29
300mm. x 6m Plain Ended.	RD300X6PEP/1	1		167E	145.02



Ridgidrain Double Socket Coupling	Code	Pack Qty.	Bulk Qty.	Product Group	Price Each £
150mm.	CRD150	1		169M	5.72
225mm.	CRD225	1		169M	11.07
300mm.	CRD300	1		169M	21.10



Ridgidrain Seal	Code	Pack Qty.	Bulk Qty.	Product Group	Price Each £
150mm.	SRD150	1		169M	2.82
225mm.	SRD225	1		169M	6.09
300mm.	SRD300	1		169M	9.10



Ridgidrain Accessories	Code	Pack Qty.	Bulk Qty.	Product Group	Price Each £
100mm Ridgidrain socket x 110mm EN1401-1 Spigot Adaptor.	ARD100110	1		169M	41.81
150mm Ridgidrain socket x 160mm EN1401-1 Spigot Adaptor.	ARD150160	1		169M	71.34



Ridgidrain Bend	Code	Pack Qty.	Bulk Qty.	Product Group	Price Each £
150mm. x 150mm 15°.	BRD150X15	1		169M	31.03
150mm. x 150mm 30°.	BRD150X30	1		169M	31.03
150mm. x 150mm 45°.	BRD150X45	1		169M	31.03
150mm. x 150mm 87.5°.	BRD150X87.5	1		169M	38.16
225mm. x 225mm 11.25°.	BRD225X11.25	1		169M	96.10
225mm. x 225mm 22.5°.	BRD225X22.5	1		169M	96.10
225mm. x 225mm 45°.	BRD225X45	1		169M	96.10
225mm. x 225mm 90°.	BRD225X90	1		169M	182.58
300mm. x 300mm 11.25°.	BRD300X11.25	1		169M	129.66
300mm. x 300mm 22.5°.	BRD300X22.5	1		169M	129.66
300mm. x 300mm 45°.	BRD300X45	1		169M	129.66
300mm. x 300mm 90°.	BRD300X90	1		169M	209.99



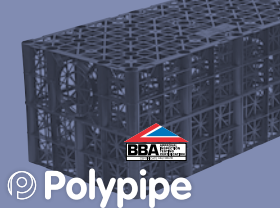

Ridgidrain Junction	Code	Pack Qty.	Bulk Qty.	Product Group	Price Each £	
150mm. x 150mm 90°.	JRD150150T	1		169M	51.77	
150mm. x 150mm 45°.	JRD150150Y	1		169M	51.77	
225mm. x 150mm 90°.	JRD225150T	1		169M	307.46	
225mm. x 150mm 45°.	JRD225150Y	1		169M	307.46	
225mm. x 225mm 90°.	JRD225225T	1		169M	307.46	
225mm. x 225mm 45°.	JRD225225Y	1		169M	307.46	
300mm. x 150mm 90°.	JRD300150T	1		169M	429.29	
300mm. x 150mm 45°.	JRD300150Y	1		169M	429.29	
300mm. x 225mm 90°.	JRD300225T	1		169M	429.29	
300mm. x 225mm 45°.	JRD300225Y	1		169M	429.29	
300mm. x 300mm 90°.	JRD300300T	1		169M	429.29	
300mm. x 300mm 45°.	JRD300300Y	1		169M	429.29	

Ridgiduct	Code	Pack Qty.	Bulk Qty.	Product Group	Price Each £
94mm. x 6m Black.	RB94X6	1	95	148E	20.09
125mm. x 6m Black.	RB125X6	1	46	148E	44.28
150mm. x 6m Black.	RB150X6	1	36	148E	51.14



Ridgiduct Coupler	Code	Pack Qty.	Bulk Qty.	Product Group	Price Each £
94mm. Black.	RBC94	1		148E	4.03
125mm. Black.	RBC125	1		148E	7.37
150mm. Black.	RBC150	1		148E	8.12



Ridgicoil	Code	Pack Qty.	Bulk Qty.	Product Group	Price Each £
50mm. x 50m Black.	RC50X50BE	1		164E	111.74
50mm. x 50m Yellow.	RC50X50Y	1		164E	111.74
60mm. x 50m Yellow Perforated.	LD6050YGAS	1		164E	122.08
63mm. x 50m Black.	RC63X50BE	1		164E	122.08
63mm. x 50m Yellow.	RC63X50Y	1		164E	122.08
63mm. x 50m Blue.	RC63X50BL	1		164E	122.08
63mm. x 50m Orange.	RC63X50SLO	1		164E	122.08
63mm. x 50m Purple (Motorway Comms & Power).	RC63X50PMCP	1		164E	122.08
110mm. x 50m Black.	RC110X50BE	1		164E	191.41
110mm. x 50m Orange.	RC110X50SLO	1		164E	191.41
110mm. x 50m Blue.	RC110X50BL	1		164E	191.41
110mm. x 50m Purple (Motorway Comms & Power).	RC110X50PMCP	1		164E	191.41
110mm. x 50m Green.	RC110X50G	1		164E	191.41
110mm. x 50m Yellow.	RC110X50Y	1		164E	191.41



Ridgicoil Coupler	Code	Pack Qty.	Bulk Qty.	Product Group	Price Each £
50mm. Black.	RCC50BE	1		165M	6.23
63mm. Black.	RCC63BE	1		165M	6.23
110mm. Black.	RCC110BE	1		165M	7.99



Polyduct	Code	Pack Qty.	Bulk Qty.	Product Group	Price Each £
38mm. x 100m Black Electric Polyduct.	PD3844X100BEPE	1		166E	423.68
50mm. x 25m Black Electric Polyduct.	PD5060X25BEPE	1		166E	210.80
50mm. x 50m Black Electric Polyduct.	PD5060X50BEPE	1		166E	421.54



Mid-Gully Yard Gully For domestic and smaller capacity industrial and commercial applications (Black HDPE, corrugated for extra strength)	Code	Pack Qty.	Bulk Qty.	Product Group	Price Each £	
Yard Gully 300mm x 600mm (110mm Spigot Outlet).	RG300/600	1	36	69M	120.43	 RG300/600
Aluminium Silt Bucket.	RGSB	1		69M	155.55	 RGSB
Cast Iron Grating (C250+ Loading Classification).	RGG	1		69M	224.86	 RGG



  

Ridgully Road Gully (Black HDPE, corrugated for extra strength)	Code	Pack Qty.	Bulk Qty.	Product Group	Price Each £	
450 x 750mm Corrugated Road Gully.	RG450/750	1	16	69M	130.46	  RG450/750
450 x 900mm Corrugated Road Gully.	RG450/900	1	16	69M	135.50	
Gully Adaptor, 150mm Twin Wall or Supersleeve.	ARG634	1	20	69M	27.60	 ARG634
Gully Adaptor, 150mm Polysewer.	PS689	1	10	161M	58.95	





# Civils





## Channel Drainage

 Polypipe

Domestic Channel	Code	Pack Qty.	Bulk Qty.	Product Group	Price Each £	
1m. Channel Drain with Plastic Grate.	DCD1000	1		114M	17.28	
Drainage System 1m Channel with slotted plastic grating	Code	Pack Qty.	Bulk Qty.	Product Group	Price Each £	
Channel Drain End Cap.	DCD1001	1		114M	4.75	DCD1002
Channel Drain End Outlet.	DCD1002	1		114M	4.75	
Channel Drain Quad Connector.	DCD1003	1		114M	30.82	
Channel Drain Sump Unit.	DCD1004	1		114M	66.75	DCD1004

NOTE: DCD Channels are to be discontinued Q1 2019. Not compatible with MCD Channels







Domestic Drainage Channel with heel guard plastic grating 	Code	Pack Qty.	Bulk Qty.	Product Group	Price Each £	
1m. Channel Drain with Plastic Grate.	MCD1000	1		114M	17.28	
Domestic Drainage Channel Accessories 	Code	Pack Qty.	Bulk Qty.	Product Group	Price Each £	
Channel Drain Quad Connector.	MCD1003	1		114M	17.28	MCD1003
Channel and SlotDrain Accessory Pack containing 2 x End Cap & 1 x Leaf Trap	MCD1005	1		114M	11.52	

Linear SlotDrain Channel 	Code	Pack Qty.	Bulk Qty.	Product Group	Price Each £	
1m. SlotDrain with Plastic Slotted Cap.	MSD1000	1		114M	22.46	
Linear SlotDrain Accessories 	Code	Pack Qty.	Bulk Qty.	Product Group	Price Each £	
SlotDrain Junction Unit.	MSD1003	1		114M	22.46	MSD1003
Channel and SlotDrain Accessory Pack containing 2 x End Cap & 1 x Leaf Trap	MCD1005	1		114M	11.52	

# Miscellaneous

## Miscellaneous



Expansion Tank	Code	Pack Qty.	Bulk Qty.	Product Group	Price Each £	
4 gallon/18 litre (18" x 12" x 12" Black).	EX104			81M	14.68	
Tank Lid	Code	Pack Qty.	Bulk Qty.	Product Group	Price Each £	
Polypropylene.	EX105			81M	9.00	
Galvanised Metal Backing Plate	Code	Pack Qty.	Bulk Qty.	Product Group	Price Each £	
	EX106			81M	2.40	
Big Tub Bucket	Code	Pack Qty.	Bulk Qty.	Product Group	Price Each £	
72 Ltr Red, Blue, Green, Brown.	TUB3			93M	21.10	
Tote Bin	Code	Pack Qty.	Bulk Qty.	Product Group	Price Each £	
540 x 370 x 290mm Black.	TOTEBIN			93M	20.08	
Tote Bin Lid	Code	Pack Qty.	Bulk Qty.	Product Group	Price Each £	
Polypropylene Black.	TBL			93M	6.48	

# Insulation

## Cavity Closer - Open Cavity

 Polypipe

Multicor Flexible Cavity Closer	Code	Pack Qty.	Bulk Qty.	Product Group	Price Each £	
50mm - 100mm - One Size Fits All (28mm Insulation) 2.44m lengths.	MULTICORFLEX	10		TDI1	28.19	

Multicor Cavity Closer	Code	Pack Qty.	Bulk Qty.	Product Group	Price Each £	
50mm - 100mm - One Size Fits All (25mm Insulation) 2.44m lengths.	MULTICOREXL244	10		TDI1	21.49	MULTICOREXL244
50mm - 100mm One Size Fits All (28mm Insulation) 2.44m lengths.	WCMULTICOR	10		TDI1	25.90	
100mm - 150mm. One size fits all. 28mm Insulation.	WCMULTICOR150	10		TDI1	34.60	WCMULTICOR150
50mm (28mm Insulation) 2.44m lengths.	WCM50	10		TDI1	16.96	
75mm (28mm Insulation) 2.44m lengths.	WCM75	10		TDI1	17.99	WCM75

Weathercor F	Code	Pack Qty.	Bulk Qty.	Product Group	Price Each £	
50mm - 100mm - One Size Fits All 30 Minute Fire Integrity - One Size Fits All. 2.44m lengths.	WCFMULTICOR	10		TDI1	31.44	WCFMULTICOR
50mm. 30 Minute Fire Integrity - 2.44m lengths.	WCF50	10		TDI1	20.80	
65mm. 30 Minute Fire Integrity - 2.44m lengths.	WCF65	10		TDI1	24.09	
75mm. 30 Minute Fire Integrity - 2.44m lengths.	WCF75	10		TDI1	25.49	
85mm. 30 Minute Fire Integrity - 2.44m lengths.	WCF85	10		TDI1	27.33	
90mm. 30 Minute Fire Integrity - 2.44m lengths.	WCF90	10		TDI1	27.98	
100mm. 30 Minute Fire Integrity - 2.44m lengths.	WCF100	10		TDI1	29.54	WCF100
125mm. 30 Minute Fire Integrity - 2.44m lengths.	WCF125	5		TDI1	44.85	
140mm. 30 Minute Fire Integrity - 2.44m lengths.	WCF140	5		TDI1	52.94	
150mm. 30 Minute Fire Integrity - 2.44m lengths.	WCF150	5		TDI1	52.94	
200mm. 30 Minute Fire Integrity - 2.44m lengths.	WCF200	5		TDI1	63.79	

Weathercor F 0.25	Code	Pack Qty.	Bulk Qty.	Product Group	Price Each £	
50mm. 0.25 "U" Value - 30 Minute Fire Integrity - 2.44m lengths.	GWC50	10		TDI1	22.02	GWC100
65mm. 0.25 "U" Value - 30 Minute Fire Integrity - 2.44m lengths.	GWC65	10		TDI1	25.72	
75mm. 0.25 "U" Value - 30 Minute Fire Integrity - 2.44m lengths.	GWC75	10		TDI1	26.75	
90mm. 0.25 "U" Value - 30 Minute Fire Integrity - 2.44m lengths.	GWC90	10		TDI1	28.31	
100mm. 0.25 "U" Value - 30 Minute Fire Integrity - 2.44m lengths.	GWC100	10		TDI1	30.24	
125mm. 0.25 "U" Value - 30 Minute Fire Integrity - 2.44m lengths.	GWC125	10		TDI1	46.90	

Prices shown are for one item excluding VAT

71

# Insulation

## Cavity Closer - Open Cavity

 Polypipe

Thermocor CC	Code	Pack Qty.	Bulk Qty.	Product Group	Price Each £
50mm. 2.44m lengths.	TC50	20		TDI5	11.88
65mm. 2.44m lengths.	TC65	20		TDI5	13.76
75mm. 2.44m lengths.	TC75	20		TDI5	15.27
85mm. 2.44m lengths.	TC85	20		TDI5	16.81
90mm. 2.44m lengths.	TC90	20		TDI5	16.81
100mm. 2.44m lengths.	TC100	20		TDI5	17.05
110mm. 2.44m lengths.	TC110	15		TDI5	20.62
125mm. 2.44m lengths.	TC125	15		TDI5	26.60
150mm. 2.44m lengths.	TC150	10		TDI5	30.97

TC100

Firestop	Code	Pack Qty.	Bulk Qty.	Product Group	Price Each £
50mm. 1 Hour Fire Integrity - 2.44m lengths.	FS50	20		TDI8	25.31
65mm. 1 Hour Fire Integrity - 2.44m lengths.	FS65	20		TDI8	25.31
70mm. 1 Hour Fire Integrity - 2.44m lengths.	FS70	20		TDI8	26.18
75mm. 1 Hour Fire Integrity - 2.44m lengths.	FS75	20		TDI8	26.18
80mm. 1 Hour Fire Integrity - 2.44m lengths.	FS80	20		TDI8	30.89
85mm. 1 Hour Fire Integrity - 2.44m lengths.	FS85	20		TDI8	32.82
90mm. 1 Hour Fire Integrity - 2.44m lengths.	FS90	20		TDI8	34.66
100mm. 1 Hour Fire Integrity - 2.44m lengths.	FS100	20		TDI8	35.77
110mm. 1 Hour Fire Integrity - 2.44m lengths.	FS110	10		TDI8	36.75
120mm. 1 Hour Fire Integrity - 2.44m lengths.	FS120	10		TDI8	38.23
125mm. 1 Hour Fire Integrity - 2.44m lengths.	FS125	10		TDI8	39.00
130mm. 1 Hour Fire Integrity - 2.44m lengths.	FS130	10		TDI8	43.41
140mm. 1 Hour Fire Integrity - 2.44m lengths.	FS140	10		TDI8	66.84
150mm. 1 Hour Fire Integrity - 2.44m lengths.	FS150	5		TDI8	68.96
175mm. 1 Hour Fire Integrity - 2.44m lengths.	FS175	5		TDI8	69.94
200mm. 1 Hour Fire Integrity - 2.44m lengths.	FS200	5		TDI8	75.02

FS100













# Insulation

## Cavity Closer - Open Cavity

 Polypipe

Firestop 0.25	Code	Pack Qty.	Bulk Qty.	Product Group	Price Each £	
50mm. 0.25 "U" Value - 1 Hour Fire Integrity - 2.44m lengths.	GFS50	20		TDI8	26.85	 GFS80  
65mm. 0.25 "U" Value - 1 Hour Fire Integrity - 2.44m lengths.	GFS65	20		TDI8	27.69	
75mm. 0.25 "U" Value - 1 Hour Fire Integrity - 2.44m lengths.	GFS75	20		TDI8	28.26	
85mm. 0.25 "U" Value - 1 Hour Fire Integrity - 2.44m lengths.	GFS85	20		TDI8	46.15	
90mm. 0.25 "U" Value - 1 Hour Fire Integrity - 2.44m lengths.	GFS90	20		TDI8	49.15	
100mm. 0.25 "U" Value - 1 Hour Fire Integrity - 2.44m lengths.	GFS100	20		TDI8	52.08	





Rigidcor F	Code	Pack Qty.	Bulk Qty.	Product Group	Price Each £	
50mm. 30 Minute Fire Integrity - 3m lengths.	RCF50	5		TDI2	32.78	 RCF100 
75mm. 30 Minute Fire Integrity - 3m lengths.	RCF75	5		TDI2	38.13	
85mm. 30 Minute Fire Integrity - 3m lengths.	RCF85	5		TDI2	40.04	
100mm. 30 Minute Fire Integrity - 3m lengths.	RCF100	5		TDI2	44.10	
120mm. 30 Minute Fire Integrity - 3m lengths.	RCF120	5		TDI2	48.95	

Rigidcor F 0.25	Code	Pack Qty.	Bulk Qty.	Product Group	Price Each £	
75mm. 0.25 "U" Value - 30 Minute Fire Integrity - 3m lengths.	GRC75	5		TDI2	45.09	 GRC100  
85mm. 0.25 "U" Value - 30 Minute Fire Integrity - 3m lengths.	GRC85	5		TDI2	46.15	
100mm. 0.25 "U" Value - 30 Minute Fire Integrity - 3m lengths.	GRC100	5		TDI2	50.78	
120mm. 0.25 "U" Value - 30 Minute Fire Integrity - 3m lengths.	GRC120	5		TDI2	56.35	

# Insulation

## Cavity Closer - Open Cavity

 Polypipe

Rigidcor F Corners	Code	Pack Qty.	Bulk Qty.	Product Group	Price Each £	
50mm.	RCFC50			TDI2	2.92	
75mm.	RCFC75			TDI2	3.29	
85mm.	RCFC85			TDI2	3.78	
100mm.	RCFC100			TDI2	4.07	
120mm.	RCFC120			TDI2	4.26	
Rigidcor F Brick Ties	Code	Pack Qty.	Bulk Qty.	Product Group	Price Each £	
Rigidcor F BrickTies.	RCFBRKTIES			TDI2	0.41	
HYCOR Subframe System	Code	Pack Qty.	Bulk Qty.	Product Group	Price Each £	
Pre-assembled subframe system, available in various sizes - 30 minute fire integrity. POA. Also available in a 0.25 "U" value range.					POA	  

# Insulation

## Cavity Closer - Closed Cavity

 Polypipe

Damcor (DPC Width/Insulation width)	Code	Pack Qty.	Bulk Qty.	Product Group	Price Each £	
165mm x 100mm. 6m Roll.	DC165	8	15	TDI3	31.86	
225mm x 150mm. 6m Roll.	DC225	6	15	TDI3	45.02	

Stonecor (DPC Width/Insulation width)	Code	Pack Qty.	Bulk Qty.	Product Group	Price Each £	 <b>30 MINS</b>
165mm x 100mm. 30 Minute Fire Integrity. 10m Roll.	SC165	5	15	TDI4	74.44	
225mm x 150mm. 30 Minute Fire Integrity. 10m Roll.	SC225	5	15	TDI4	104.12	

  

Stonecor 0.25 (DPC Width/Insulation width)	Code	Pack Qty.	Bulk Qty.	Product Group	Price Each £	 <b>0.25 U</b> <b>30 MINS</b>
165mm x 100mm. 0.25 "U" Value. 30 Minute Fire Integrity. 10m Roll.	GSC165	5	15	TDI4	105.19	
225mm x 150mm. 0.25 "U" Value. 30 Minute Fire Integrity. 10m Roll.	GSC225	5	15	TDI4	117.90	

# Insulation

## Cavity Closer - Party Wall

 Polypipe

Cavity Stop (DPC Width x Insulation Width x Insulation Height)	Code	Pack Qty.	Bulk Qty.	Product Group	Price Each £	
340x260x100mm. 1 Hour Fire Integrity - 7.5m Roll.	CS340X260X100	2		TDI11	225.31	
340x300x100mm. 1 Hour Fire Integrity - 7.5m Roll.	CS340X300X100	2		TDI11	235.42	
400x300x100mm. 1 Hour Fire Integrity - 7.5m Roll.	CS400X300X100	2		TDI11	308.39	

# Insulation

## Acoustic Cavity Sock

 Polypipe

Acoustic Cavity Sock (First measurement is the cavity width)	Code	Pack Qty.	Bulk Qty.	Product Group	Price Each £
50mm x 75mm. 2 Hour Fire Integrity - 2.44m lengths.	CSOCK75X50			TDI10	12.34
50mm x 80mm. 2 Hour Fire Integrity - 2.44m lengths.	CSOCK80X50			TDI10	14.48
50mm x 100mm. 2 Hour Fire Integrity - 2.44m lengths.	CSOCK100X50			TDI10	14.48
50mm x 140mm. 2 Hour Fire Integrity - 2.44m lengths.	CSOCK140X50			TDI10	19.92
70mm x 100mm. 2 Hour Fire Integrity - 2.44m lengths.	CSOCK100X70			TDI10	25.54
75mm x 50mm. 2 Hour Fire Integrity - 2.44m lengths.	CSOCK75X50			TDI10	12.34
75mm x 75mm. 2 Hour Fire Integrity - 2.44m lengths.	CSOCK75X75			TDI10	12.55
75mm x 90mm. 2 Hour Fire Integrity - 2.44m lengths.	CSOCK90X75			TDI10	16.83
75mm x 100mm. 2 Hour Fire Integrity - 1.22m lengths.	CSOCK100X75			TDI10	11.98
75mm x 125mm. 2 Hour Fire Integrity - 2.44m lengths.	CSOCK125X75			TDI10	21.91
75mm x 150mm. 2 Hour Fire Integrity - 2.44m lengths.	CSOCK150X75			TDI10	21.99
75mm x 155mm. 2 Hour Fire Integrity - 2.44m lengths.	CSOCK155X75			TDI10	25.72
75mm x 175mm. 2 Hour Fire Integrity - 2.44m lengths.	CSOCK175X75			TDI10	32.05
75mm x 275mm. 2 Hour Fire Integrity - 2.44m lengths.	CSOCK275X75			TDI10	41.27
80mm x 50mm. 2 Hour Fire Integrity - 2.44m lengths.	CSOCK80X50			TDI10	14.48
90mm x 75mm. 2 Hour Fire Integrity - 2.44m lengths.	CSOCK90X75			TDI10	16.83
100mm x 50mm. 2 Hour Fire Integrity - 2.44m lengths.	CSOCK100X50			TDI10	14.48
100mm x 70mm. 2 Hour Fire Integrity - 2.44m lengths.	CSOCK100X70			TDI10	25.54
100mm x 75mm. 2 Hour Fire Integrity - 1.22m lengths.	CSOCK100X75			TDI10	11.98
100mm x 100mm. 2 Hour Fire Integrity - 2.44m lengths.	CSOCK100X100			TDI10	22.69
100mm x 125mm. 2 Hour Fire Integrity - 2.44m lengths.	CSOCK125X100			TDI10	24.82
100mm x 150mm. 2 Hour Fire Integrity - 2.44m lengths.	CSOCK150X100			TDI10	29.99
100mm x 170mm. 2 Hour Fire Integrity - 2.44m lengths.	CSOCK170X100			TDI10	38.94
100mm x 200mm. 2 Hour Fire Integrity - 2.44m lengths.	CSOCK200X100			TDI10	41.92
100mm x 300mm. 2 Hour Fire Integrity - 2.44m lengths.	CSOCK300X100			TDI10	57.89



**2**  
HOUR

# Insulation

## Loft Hatch



Loft Hatch	Code	Pack Qty.	Bulk Qty.	Product Group	Price Each £	
Hinge down uninsulated quarter turn catch (c/w Opening Handle).	LH4			85M	84.62	
Hinge down uninsulated lockable.	LH4WL			85M	102.67	
Hinge down insulated quarter turn catch 0.25 "U" Value (c/w Opening Handle).	LH.25			85M	128.66	
Hinge down insulated quarter turn catch 0.35 "U" Value (c/w Opening Handle).	.35TDI			85M	109.99	
Hinge down insulated lockable 0.35 "U" Value.	.35TDIWL			85M	135.84	

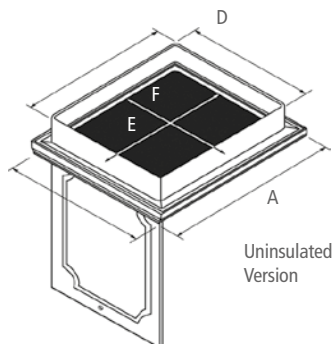
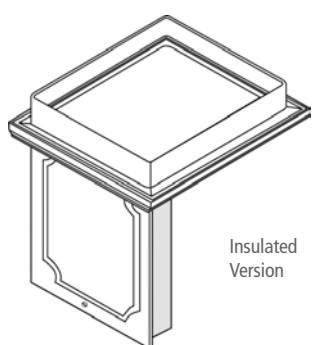

- A 733mm
- B 656mm
- C 639mm
- D 562mm
- E 600mm
- F 532mm

# Spares and Ancillaries

Seals	Code	Pack Qty.	Bulk Qty.	Product Group	Price Each £
110mm Socketed Pipe Seal (Nitrile)	PRD10N	1	N/A	143M	3.16
110mm Underground Fitting Seal (Nitrile)	PRD4N	1	N/A	143M	3.16
160mm Underground Fitting Seal (Nitrile)	PRD2N	1	500	143M	4.89
150mm Polysewer Seal (Nitrile)	PRD53N	1	500	143M	4.89
225mm Polysewer Seal (Nitrile)	PRD54N	1	N/A	143M	8.72
300mm Polysewer Seal (Nitrile)	PRD55N	1	N/A	143M	18.95
200mm Sewerdrain Pipe Seal	BODEBL200	1	N/A	RAWM	5.53
250mm Sewerdrain Pipe Seal	BODEBL250	1	N/A	RAWM	6.43
315mm Sewerdrain Pipe Seal	F315	10	N/A	W88E	13.52

Screws	Code	Pack Qty.	Bulk Qty.	Product Group	Price Each £
For UG501, UG502 & UG510 Inspection Chamber Cover and Frame	CF5510	4	100	51M	4.85

MDPE End Caps	Code	Pack Qty.	Bulk Qty.	Product Group	Price Each £
20mm Black End Cap	20BLACKCAP	10	N/A	W70E	0.57
25mm Black End Cap	25BLACKCAP	10	4500	W70E	0.58
32mm Black End Cap	32BLACKCAP	10	2000	W70E	0.60
50mm Black End Cap	50BLACKCAP	10	800	W70E	0.82
63mm Black End Cap	63BLACKCAP	10	800	W70E	1.50

Code	Price £	Page
2025	64.83	40
2050	129.66	40
2525	82.71	40
2550	165.36	40
3225	138.59	40
3250	277.19	40
4050	431.03	40
4731	34.54	49
4901	15.06	42
5006	79.74	40
5025	332.08	40
5050	664.08	40
6306	124.97	40
6325	520.83	40
6350	1041.64	40
20100	259.24	40
20150	388.92	40
25100	330.79	40
25150	496.15	40
30920	1.76	44
30925	2.23	44
30932	2.62	44
30940	5.19	44
30950	5.13	44
30963	7.38	44
31050	279.22	48
31063	411.24	48
32100	554.34	40
32150	831.52	40
40020	5.03	41
40025	5.63	41
40032	13.57	41
40040	18.75	41
40050	31.05	41
40063	45.58	41
40100	862.12	40
40120	6.88	43
40125	10.12	43
40132	16.97	43
40140	29.19	43
40150	37.36	43
40163	49.52	43
40220	9.73	43
40225	15.06	43
40232	21.10	43
40240	40.39	43
40250	47.28	43
40263	70.55	43
40320	6.54	42
40325	7.16	42
40332	9.81	42
40340	20.31	42
40350	26.42	42
40363	38.05	42
40420	5.06	42
40425	6.64	42
40432	10.19	42
40440	19.08	42
40450	24.14	42
40463	32.55	42

Code	Price £	Page
40625	11.50	41
40632	19.82	41
40640	26.19	41
40650	36.31	41
40920	6.64	44
40925	7.88	44
40932	10.92	44
40940	22.88	44
40950	28.19	44
40963	39.35	44
41020	61.86	48
41025	84.67	48
41032	147.27	48
41125	19.38	44
41132	23.40	44
41320	24.47	48
41325	30.40	48
42120	6.54	43
42125	9.41	43
42132	15.48	43
42140	18.81	43
42150	34.03	43
42163	44.22	43
42220	9.36	44
42225	15.48	44
42232	20.81	44
42240	31.95	44
42250	43.70	44
42263	62.21	44
42320	5.49	43
42325	6.17	43
42332	10.71	43
42420	14.24	44
42425	17.05	44
42525	13.21	43
42620	31.41	48
42625	46.44	48
42632	76.17	48
46420	0.65	45
46425	0.76	45
46432	0.97	45
46440	1.39	45
46450	1.47	45
46463	1.67	45
46820	3.80	46
46825	4.70	46
46832	6.85	46
46920	2.32	46
46925	2.62	46
46932	3.04	46
46940	6.39	46
47021	9.22	49
47032	18.10	49
47043	18.31	49
47240	9.67	47
47312	25.89	49
47334	28.67	49
47450	1.71	45
47463	1.99	45
47620	44.38	49

Code	Price £	Page
47625	48.28	49
47632	66.01	49
47720	31.85	48
47725	41.47	48
47820	6.54	42
47825	8.34	42
47832	17.53	42
48120	7.56	42
48125	9.67	42
48320	11.91	48
48325	14.72	48
49012	7.56	42
49034	9.92	42
49120	31.41	48
49125	46.44	48
50100	1328.15	40
50150	1992.30	40
63100	2083.34	40
63150	3124.96	40
469329	3.04	46
470112	9.00	49
470134	9.00	49
470212	9.22	49
470234	9.22	49
479116	38.89	46
479127	9.50	46
479129	11.28	46
479349	15.86	46
479385	9.98	46
3085020	12.75	49
3085025	12.75	49
3085032	12.75	49
3086320	15.28	49
3086325	15.28	49
3086332	15.28	49
4012520	13.86	43
4032512	6.77	42
4042512	6.54	42
4063220	19.82	41
4065032	36.31	41
4113220	21.84	44
4132534	29.32	48
4682515	5.60	46
4701121	5.96	49
4701141	9.46	49
4702112	9.22	49
4703412	5.52	49
4712520	4.13	45
4713220	5.60	45
4713225	5.60	45
4715020	11.42	45
4715025	11.42	45
4715032	11.42	45
4716320	17.05	45
4716325	17.05	45
4716332	17.05	45
4716350	17.05	45
4722038	3.80	47
4722512	5.32	47
4723234	6.39	47



# Index

Code	Price £	Page
4772515	32.37	48
4782515	7.42	42
4783222	16.69	42
4793411	29.32	46
4802520	4.13	45
4803220	5.60	45
4803225	5.60	45
4805020	11.42	45
4805025	11.42	45
4805032	11.42	45
4806320	17.05	45
4806325	17.05	45
4806332	17.05	45
4806350	17.05	45
4812512	9.67	42
4832512	12.18	48
4841522	17.19	41
4842127	19.22	41
4842735	26.32	41
4851522	17.93	41
4852127	21.26	41
4852735	26.32	41
4882735	31.55	41
47011212	5.96	49
47011234	9.46	49
470112114	5.96	49
.35TDI	109.99	78
.35TDIWL	135.84	78
IC6BS10	705.26	26
PSMFC160/30	POA	58
PSMSTA160/15	POA	58
20100YE	POA	53
2050YE	POA	53
20BLACKCAP	0.57	79
2506YE	POA	53
25100YE	POA	53
2550YE	POA	53
25BLACKCAP	0.58	79
3206YE	POA	53
32100G	475.30	54
32100YE	POA	53
32250G	1188.30	54
32300G	1425.91	54
32400G	1901.21	54
3250YE	POA	53
32BLACKCAP	0.60	79
40020S	7.16	41
40025S	8.67	41
40032S	18.81	41
40040S	26.19	41
40050S	39.35	41
40063S	54.69	41
40100G	739.21	54
40250G	1848.26	54
40300G	2217.62	54
40400G	2956.81	54
465C1	1.91	46
465C112	4.53	46
465C114	3.35	46
465C12	1.44	46

Code	Price £	Page
465C2	6.85	46
465C34	1.74	46
465D1	1.76	46
465D112	4.53	46
465D114	3.35	46
465D12	1.26	46
465D34	1.74	46
466C1	1.54	47
466C112	4.53	47
466C114	3.35	47
466C12	1.13	47
466C2	6.85	47
466C34	1.44	47
466D1	1.76	47
466D112	4.53	47
466D114	3.35	47
466D2	1.19	47
466D2	6.85	47
466D34	1.44	47
466D38	1.85	47
467HG1	2.32	47
467HG112	5.89	47
467HG114	5.06	47
467HG12	1.57	47
467HG34	1.89	47
467NG1	2.32	47
467NG112	5.89	47
467NG114	5.06	47
467NG12	1.57	47
467NG2	9.53	47
467NG34	2.18	47
5008100B	801.92	40
500850B	400.95	40
50BLACKCAP	0.82	79
630611YE	POA	53
6308100B	1283.04	40
630850B	641.51	40
6310011YE	POA	53
635011YE	POA	53
63BLACKCAP	1.50	79
750611YE	POA	53
7512011YE	POA	53
AFV110	304.26	7
AFV160	374.96	7
ARD100110	41.81	57
ARD100110	41.81	65
ARD150160	71.34	57
ARD150160	71.34	65
ARG634	27.60	68
BODEBL200	5.53	79
BODEBL250	6.43	79
BRD150X15	31.03	65
BRD150X30	31.03	65
BRD150X45	31.03	65
BRD150X87.5	38.16	65
BRD225X11.25	96.10	65
BRD225X22.5	96.10	65
BRD225X45	96.10	65
BRD225X90	182.58	65
BRD300X11.25	129.66	65

Code	Price £	Page
BRD300X22.5	129.66	65
BRD300X45	129.66	65
BRD300X90	209.99	65
CDJ10M	14.73	64
CDJ160M	28.23	64
CF250	14.76	39
CF5510	4.85	79
CLH500	9.97	20
CRD150	5.72	65
CRD225	11.07	65
CRD300	21.10	65
CS340X260X100	225.31	76
CS340X300X100	235.42	76
CS400X300X100	308.39	76
CSOCK100X100	22.69	77
CSOCK100X50	14.48	77
CSOCK100X50	14.48	77
CSOCK100X70	25.54	77
CSOCK100X70	25.54	77
CSOCK100X75	11.98	77
CSOCK100X75	11.98	77
CSOCK125X100	24.82	77
CSOCK125X75	21.91	77
CSOCK140X50	19.92	77
CSOCK150X100	29.99	77
CSOCK150X75	21.99	77
CSOCK155X75	25.72	77
CSOCK170X100	38.94	77
CSOCK175X75	32.05	77
CSOCK200X100	41.92	77
CSOCK275X75	41.27	77
CSOCK300X100	57.89	77
CSOCK75X50	12.34	77
CSOCK75X50	12.34	77
CSOCK75X75	12.55	77
CSOCK80X50	14.48	77
CSOCK80X50	14.48	77
CSOCK90X75	16.83	77
CSOCK90X75	16.83	77
DC165	31.86	75
DC225	45.02	75
DCD1000	17.28	69
DCD1001	4.75	69
DCD1002	4.75	69
DCD1003	30.82	69
DCD1004	66.75	69
DUCT 2A	16.88	63
DUCT 2AC	3.93	63
DUCT 2AX45	8.92	63
DUCT 2AX90	8.92	63
DUCT 3	24.69	63
DUCT 3C	5.93	63
DUCT 3X45	9.92	63
DUCT 3X90	9.92	63
DUCT 4B	28.31	63
DUCT 4BC	6.58	63
DUCT 4BX45	12.34	63
DUCT 4BX90	12.34	63
DUCT 6B	51.49	63
DUCT 6BC	7.26	63

# Index

Code	Price £	Page
DUCT 6BX45	28.63	63
DUCT 6BX90	28.63	63
EX104	14.68	70
EX105	9.00	70
EX106	2.40	70
F315	13.52	79
FRK500	16.62	20
FRK500	16.62	22
FRK501	0.19	20
FRK503	33.23	22
FRK504	15.73	19
FS100	35.77	72
FS110	36.75	72
FS120	38.23	72
FS125	39.00	72
FS130	43.41	72
FS140	66.84	72
FS150	68.96	72
FS175	69.94	72
FS200	75.02	72
FS50	25.31	72
FS65	25.31	72
FS70	26.18	72
FS75	26.18	72
FS80	30.89	72
FS85	32.82	72
FS90	34.66	72
GFC100	17.55	39
GFS100	52.08	73
GF50	26.85	73
GF565	27.69	73
GF575	28.26	73
GF585	46.15	73
GF590	49.15	73
GRC100	50.78	73
GRC120	56.35	73
GRC75	45.09	73
GRC85	46.15	73
GSC165	105.19	75
GSC225	117.90	75
GWC100	30.24	71
GWC125	46.90	71
GWC50	22.02	71
GWC65	25.72	71
GWC75	26.75	71
GWC90	28.31	71
HCC100	5.60	64
HCC160	6.34	64
HCC60	4.46	64
HCC80	4.98	64
IC6BS12	948.42	26
IC6BS6	568.42	26
IC6CRS10	731.58	26
IC6CRS12	948.42	26
IC6CRS6	584.21	26
IC6EC10	35.53	26
IC6EC6	18.42	26
IC6PS10	35.53	26
IC6PS6	18.42	26
IC6RC	149.50	26

Code	Price £	Page
IC6UG10	35.53	26
IC6UG6	18.42	26
ICDB1	626.87	22
ICDB2	626.87	22
ICDB3	626.87	22
ICDR1	78.94	22
ICDR1	78.94	58
ICDR2	165.71	22
ICDR4	339.27	22
ICDR8	686.35	22
INS1025-2-HTG	398.34	55
INS1032-2-HTG	469.29	55
INS1525-2-HTG	597.53	55
INS1532-2-HTG	703.95	55
INS160-25-2DC	10.20	55
INS160-32-2DC	10.20	55
INS160-3225-2HSC	102.54	55
INS160IKC	83.06	55
INS2025-2-HTG	796.68	55
INS2032-2-HTG	938.60	55
INS25FC-HTG	4.73	55
INS25FP-HTG	8.55	55
INS25MC-HTG	24.27	55
INS32FC-HTG	6.95	55
INS32FP-HTG	19.43	55
INS32MC-HTG	31.82	55
JRD150150T	51.77	66
JRD150150Y	51.77	66
JRD225150T	307.46	66
JRD225150Y	307.46	66
JRD225225T	307.46	66
JRD225225Y	307.46	66
JRD300150T	429.29	66
JRD300150Y	429.29	66
JRD300225T	429.29	66
JRD300225Y	429.29	66
JRD300300T	429.29	66
JRD300300Y	429.29	66
LD100100B	518.22	64
LD10025B	145.92	64
LD10050B	291.83	64
LD16025B	363.62	64
LD16045B	619.21	64
LD60150B	294.16	64
LD6025B	55.23	64
LD6050B	110.37	64
LD6050YGAS	122.08	67
LD80100B	294.13	64
LD8025B	82.82	64
LD8050B	165.67	64
LH.25	128.66	78
LH4	84.62	78
LH4WL	102.67	78
LUBX1	24.39	39
LUBX2.5	60.85	39
MCD1000	17.28	69
MCD1003	17.28	69
MCD1005	11.52	69
MCD1005	11.52	69
MSD1000	22.46	69

Code	Price £	Page
MSD1003	22.46	69
MULTICOREXL244	21.49	71
MULTICORFLEX	28.19	71
PB778	37.62	52
PB781	24.80	52
PC04	3.66	4
PD3844X100BEPE	423.68	67
PD5060X25BEPE	210.80	67
PD5060X50BEPE	421.54	67
PGF2515TC	55.61	51
PGF2522TC	64.74	51
PGF2525TC	30.36	51
PGF2590E	52.37	51
PGF25FTC	17.50	51
PGF25MTC	17.50	51
PGF255C	35.17	51
PGF25T	93.71	51
PGF3232TC	45.48	51
PGF3290E	108.62	51
PGF32FTC	27.83	51
PGF32MTC	27.83	51
PGF325C	50.76	51
PGF32T	144.61	51
PGF40025	11.85	50
PGF40032	19.34	50
PGF40125	14.43	50
PGF40132	22.12	50
PGF40225	21.88	50
PGF40232	28.52	50
PGF402525	9.56	50
PGF403232	17.53	50
PGF40325	9.79	50
PGF40332	12.67	50
PGF40425	8.89	50
PGF40432	13.19	50
PGF40632	25.60	50
PGF40925	13.03	50
PGF40932	21.27	50
PGF41025	102.19	50
PGF41032	171.55	50
PGF47825	14.54	50
PGF4782515	13.35	50
PGF47832	22.83	50
PGF6363TC	107.97	51
PGF6390E	242.87	51
PGF63FTC	81.85	51
PGF63MTC	109.88	51
PGF635C	136.44	51
PGF63T	316.59	51
PG2550	681.09	50
PGP3250	879.83	50
PGP6325	1203.58	50
PGP6350	2407.15	50
PGP636	288.87	50
POLYSOAK	POA	57
PRD10N	3.16	79
PRD2N	4.89	79
PRD4N	3.16	79
PRD53N	4.89	79
PRD54N	8.72	79

# Index

Code	Price £	Page
PRD55N	18.95	79
PS1000	53.99	27
PS1001	53.99	27
PS1003	153.47	28
PS1005	294.57	27
PS1009	152.16	28
PS10101	81.36	29
PS10102	58.95	29
PS10105	58.95	29
PS1011	198.08	28
PS1020	113.99	29
PS1021	132.74	27
PS1030	103.33	27
PS1031	183.18	28
PS1031RS	198.09	28
PS1032	106.82	27
PS1035RS	219.07	28
PS1060	206.74	27
PS1062	219.80	27
PS1067	156.67	28
PS1089	58.95	29
PS1200	109.83	27
PS1201	109.83	27
PS1203	269.00	28
PS1205	630.26	27
PS1209	248.20	28
PS12100	599.93	28
PS12101	110.95	29
PS12102	58.95	26
PS12102	58.95	29
PS12105	58.95	29
PS1211	345.03	28
PS1220	200.63	29
PS1221	242.33	27
PS1230	148.88	27
PS1231	297.99	28
PS1231RS	327.47	28
PS1232	162.22	27
PS1235RS	363.90	28
PS1260	315.20	27
PS1262	335.85	27
PS1267	261.15	28
PS1289	58.95	29
PS600	22.13	27
PS601	22.13	27
PS603	38.01	28
PS605	77.35	27
PS609	38.01	28
PS6101	16.22	29
PS6103	15.58	30
PS6104	15.58	30
PS6105	58.95	29
PS611	44.46	28
PS620	38.63	29
PS621	45.55	27
PS6225	180.84	28
PS623	77.35	27
PS630	37.93	27
PS632	41.65	27
PS634	58.95	29

Code	Price £	Page
PS635RS	71.14	28
PS643RS	71.14	28
PS660	75.90	27
PS662	87.09	27
PS667	38.01	28
PS670	192.82	28
PS689	58.95	29
PS689	58.95	68
PS696	58.95	29
PSC1	3.38	30
PSM1A	POA	56
PSM2	POA	56
PSM3	POA	56
PSM4	POA	56
PSM5	POA	56
PSMACCESS	POA	57
PSMBBSC	3.23	57
PSMCLIP	2.27	57
PSMFA110	68.33	57
PSMFA150	105.65	57
PSMFA160	112.89	57
PSMSC	1.87	57
PSMST110	POA	58
PSMST160	POA	58
PSSP1	2.77	29
PSSP2	5.61	29
PSSP2	5.61	29
PSSP3	11.63	29
PSUR150	26.88	29
PSUR300	44.40	29
PUD110	52.52	12
PUD160	86.37	12
RB125X6	44.28	67
RB150X6	51.14	67
RB94X6	20.09	67
RBC125	7.37	67
RBC150	8.12	67
RBC94	4.03	67
RC110X50BE	191.41	67
RC110X50BL	191.41	67
RC110X50G	191.41	67
RC110X50PMCP	191.41	67
RC110X50SLO	191.41	67
RC110X50Y	191.41	67
RC50X50BE	111.74	67
RC50X50Y	111.74	67
RC63X50BE	122.08	67
RC63X50BL	122.08	67
RC63X50PMCP	122.08	67
RC63X50SLO	122.08	67
RC63X50Y	122.08	67
RCC110BE	7.99	67
RCC50BE	6.23	67
RCC63BE	6.23	67
RCF100	44.10	73
RCF120	48.95	73
RCF50	32.78	73
RCF75	38.13	73
RCF85	40.04	73
RCFBRKTIES	0.41	74

Code	Price £	Page
RCFC100	4.07	74
RCFC120	4.26	74
RCFC50	2.92	74
RCFC75	3.29	74
RCFC85	3.78	74
RD150X6PE/1	35.63	65
RD150X6PEP/1	37.37	65
RD225X6PE/1	88.83	65
RD225X6PEP/1	93.29	65
RD300X6PE/1	138.09	65
RD300X6PEP/1	145.02	65
RG300/600	120.43	68
RG450/750	130.46	68
RG450/900	135.50	68
RGG	224.86	68
RGSB	155.55	68
RSW450X3PE8	260.00	25
RSW600X3PE8	394.74	26
RWH.GA.RWP25.25	92.81	62
RWH.GA.RWP32.25	155.56	62
RWH.RH.A.RC	560.54	60
RWH.RH.A.TE	222.54	60
RWH.RH.A.TE2	141.35	60
RWH.RH.BGT.1	1571.77	59
RWH.RH.BGT.1	1571.77	61
RWH.RH.BGT.10	6058.55	59
RWH.RH.BGT.2	1910.82	59
RWH.RH.BGT.3	2352.80	59
RWH.RH.BGT.4	2882.75	59
RWH.RH.BGT.5	3196.10	59
RWH.RH.BGT.7.5	5107.41	59
RWH.RH.BGT.V.1	1757.46	60
RWH.RH.BGT.V.10	6429.93	60
RWH.RH.BGT.V.2	2282.20	60
RWH.RH.BGT.V.3	2724.18	60
RWH.RH.BGT.V.4	3254.13	60
RWH.RH.BGT.V.5	3567.49	60
RWH.RH.BGT.V.7.5	5478.81	60
RWH.RH.CSCS.G.HOME	152.18	62
RWH.RH.CSCS.P.HOME	301.16	62
RWH.RH.CSCS.RG	127.28	61
RWH.RH.PG.1000	1318.10	61
RWH.RH.PG.15	1651.56	61
RWH.RH.PG.25	1734.15	61
RWH.RH.PG.G	666.67	61
RWH.RH.PP.1000	1198.26	61
RWH.RH.PP.15	1623.15	61
RWH.RH.PP.25	1704.31	61
SC125	13.55	39
SC165	74.44	75
SC225	104.12	75
SC250	20.65	39
SC500	37.42	39
SFA210	172.83	23
SFA238	129.63	23
SFA430	459.32	23
SFA431	49.68	23
SFA432	99.36	23
SFA434	198.74	23
SFA437	347.77	23

Code	Price £	Page
SFA440	721.79	24
SFA441	57.42	24
SFA442	114.84	24
SFA444	229.65	24
SFA448	459.32	24
SFA530	524.94	23
SFA670	721.79	24
SFA671	721.79	24
SFARB1	176.70	25
SFARB2	152.70	25
SFARB3	152.70	25
SFARC	98.68	25
SG100	17.55	39
SG300	29.20	39
SG500	26.45	39
SIL500	79.53	39
SRD150	2.82	65
SRD225	6.09	65
SRD300	9.10	65
SRSW4508	33.27	25
SRSW6008	39.47	26
SS700	33.89	16
SS701	57.17	16
SS702	55.15	16
SS703	42.91	16
SS704	78.18	16
SS705	42.43	16
SS706	75.02	16
SS707	39.54	16
TBL	6.48	70
TC100	17.05	72
TC110	20.62	72
TC125	26.60	72
TC150	30.97	72
TC50	11.88	72
TC65	13.76	72
TC75	15.27	72
TC85	16.81	72
TC90	16.81	72
TOTEBIN	20.08	70
TUB3	21.10	70
UDC200	271.60	23
UDC700	233.87	19
UDC700	233.87	23
UDC750	357.14	21
UDC750	357.14	24
UFC430	31.77	10
UFC432	40.88	10
UFC460	63.31	10
UFC462	70.53	10
UFC630	85.32	10
UFC632	103.15	10
UFC660	154.05	10
UFC662	178.23	10
UG1001	53.00	31
UG1004	179.62	32
UG1006	292.51	32
UG1010	143.70	32
UG1012	179.62	32
UG1016	207.61	32

Code	Price £	Page
UG1017	280.28	32
UG1020	65.88	33
UG1021	84.22	33
UG1030	101.40	31
UG1032	104.00	31
UG1036	191.00	32
UG1060	202.80	31
UG1062	205.92	31
UG1068	143.70	32
UG1069	304.20	31
UG1200	102.00	31
UG1201	102.00	31
UG1204	275.19	32
UG1206	462.37	32
UG1210	192.63	32
UG1212	275.19	32
UG1216	332.91	32
UG1217	369.90	32
UG1218	369.90	32
UG1220	117.62	26
UG1220	117.62	33
UG1221	131.61	33
UG1230	149.85	31
UG1232	162.00	31
UG1236	332.91	32
UG1260	299.70	31
UG1262	320.76	31
UG1268	192.63	32
UG1269	449.55	31
UG253	7.94	14
UG254	9.07	14
UG301	13.40	5
UG304	23.37	5
UG312	23.37	5
UG320	13.21	7
UG324	41.37	6
UG330	52.52	4
UG360	104.82	4
UG388	6.97	19
UG388	6.97	23
UG388B	6.97	19
UG400	11.20	5
UG401	11.21	5
UG402	8.75	5
UG403	23.80	5
UG404	18.82	5
UG405	41.65	6
UG406	34.51	6
UG407	25.90	5
UG408	21.60	5
UG409	23.55	5
UG410	19.60	5
UG411	25.10	6
UG412	19.82	6
UG413	29.83	8
UG414	23.19	8
UG414AST	54.67	13
UG414B	31.12	8
UG415	7.25	8
UG416S	94.87	12

Code	Price £	Page
UG417	29.41	9
UG417S	8.26	9
UG4176	7.25	9
UG4177	5.57	9
UG418	12.75	7
UG419	156.35	20
UG419	156.35	24
UG420	13.80	7
UG421	23.19	7
UG422	80.65	12
UG422S	87.29	12
UG423	41.65	6
UG424	34.51	6
UG425	62.52	7
UG425AST	112.94	13
UG426	7.25	7
UG427	79.49	7
UG427AST	117.60	13
UG427R	18.09	7
UG427RAST	49.46	13
UG427S	17.08	7
UG428	30.85	8
UG428AST	62.10	13
UG429	7.61	8
UG430	35.45	4
UG431	59.65	20
UG432	45.65	4
UG433	101.70	7
UG434	26.32	14
UG435	12.00	15
UG436	100.51	19
UG437	51.80	19
UG438	27.16	19
UG439	84.82	19
UG439	84.82	23
UG440†	120.95	20
UG442	19.55	7
UG443	15.55	8
UG444	162.29	20
UG444	162.29	24
UG445	8.41	21
UG446	99.25	7
UG447	79.35	17
UG448	46.33	17
UG449	12.41	17
UG450L	21.16	17
UG450R	21.16	17
UG451L	21.16	17
UG451R	21.16	17
UG452L	36.79	18
UG452R	36.79	18
UG453L	36.79	18
UG453R	36.79	18
UG454	29.82	13
UG455	18.09	15
UG456	18.09	15
UG457	20.57	15
UG459	22.62	14
UG460	70.65	4
UG461	23.81	15

# Index

Code	Price £	Page
UG462	78.70	4
UG463	28.32	14
UG464	21.79	14
UG465	132.42	4
UG466	34.03	19
UG467	22.62	5
UG468	19.60	5
UG469	141.79	4
UG470	14.44	8
UG471	76.89	6
UG472	67.61	6
UG473	56.52	6
UG474	56.78	6
UG475	24.49	17
UG476	24.49	17
UG477L	42.73	18
UG477R	42.73	18
UG478L	42.73	18
UG478R	42.73	18
UG479	39.18	6
UG480	20.39	7
UG481	97.96	18
UG482	83.89	18
UG483	28.51	6
UG484	23.75	5
UG485	9.75	14
UG486	28.02	14
UG487	24.19	14
UG488	7.50	20
UG488	7.50	22
UG488	7.50	24
UG488	7.50	58
UG489	18.80	5
UG490	167.11	21
UG491	106.88	21
UG492	23.81	15
UG493	9.75	14
UG494	30.70	6
UG496	182.85	21
UG497	117.62	20
UG498	51.58	8
UG499	102.63	19
UG499	102.63	23
UG501	93.09	19
UG502	86.92	19
UG510	161.89	20
UG510	161.89	22
UG510	161.89	58
UG511	124.82	20
UG511	124.82	22
UG511	124.82	58
UG513	392.30	20
UG513	392.30	22
UG513	392.30	24
UG514	88.07	22
UG514	88.07	24
UG515	8.15	20
UG515	8.15	22
UG515	8.15	58
UG521	75.01	12

Code	Price £	Page
UG522	67.46	12
UG523	75.01	12
UG537	84.57	19
UG543	84.66	13
UG601	26.49	5
UG601	26.49	10
UG602	21.06	5
UG603	78.98	5
UG604	67.61	5
UG605	146.27	6
UG606	136.53	6
UG609	82.31	5
UG610	70.22	5
UG6106	74.36	14
UG611	78.98	5
UG612	67.61	5
UG616	447.21	21
UG620	28.02	7
UG621	46.35	7
UG621	46.35	10
UG621	46.35	57
UG622S	200.12	12
UG623	146.27	6
UG624	136.53	6
UG630	99.90	4
UG632	120.81	4
UG634	39.61	14
UG635	126.85	6
UG636	115.37	6
UG643	126.85	6
UG644	115.37	6
UG645	8.97	21
UG647	122.38	17
UG648	59.94	17
UG649	22.03	17
UG650L	44.85	17
UG650R	44.85	17
UG651L	44.85	17
UG651R	44.85	17
UG654L	69.18	18
UG654R	69.18	18
UG659	33.81	14
UG660	171.90	4
UG662	198.86	4
UG663	61.10	14
UG664	45.51	14
UG665	249.52	4
UG667	82.31	5
UG668	70.22	5
UG669	279.20	4
UG670†	155.55	20
UG671	139.02	6
UG672	102.12	6
UG681	149.04	18
UG682	128.15	18
UG696	41.57	14
UG697	35.79	14
UG801	37.03	31
UG803	57.87	32
UG804	48.22	32

Code	Price £	Page
UG805	126.30	32
UG806	120.29	32
UG809	52.08	32
UG810	43.40	32
UG812	48.22	32
UG820	21.46	33
UG821	48.58	33
UG830	72.90	31
UG831	85.51	32
UG832	76.73	31
UG835	85.51	32
UG836	85.51	32
UG837	85.51	32
UG860	145.79	31
UG862	151.93	31
UG868	43.40	32
UG869	218.69	31
UG945R	32.85	17
UG946L	32.85	17
UG947R	32.85	17
UG948L	32.85	17
UGR1099	29.23	31
UGR1299	51.42	31
UGR699	23.44	4
UGT899	21.30	31
UR401	10.15	10
UR403	21.58	11
UR404	17.05	10
UR405	37.77	11
UR406	31.44	11
UR409	21.30	11
UR410	17.75	10
UR411	21.58	11
UR412	17.05	10
UR423	40.47	11
UR424	31.44	11
UR467	20.51	11
UR468	17.75	10
UR603	71.61	11
UR604	61.30	10
UR605	125.71	11
UR606	124.35	11
UR609	70.73	11
UR610	60.36	10
UR611	71.61	11
UR612	61.30	10
UR635	109.55	11
UR636	99.65	11
UR667	70.73	11
UR668	60.36	10
URP720	231.32	19
URP760	214.55	21
USA43	53.30	12
USA62	24.19	12
USA63	25.95	12
USA643	117.22	12
USA662	54.51	12
USB413	75.01	12
USH33	12.72	4
USH43	13.94	4

Code	Price £	Page
USH643	30.03	4
WCF100	29.54	71
WCF125	44.85	71
WCF140	52.94	71
WCF150	52.94	71
WCF200	63.79	71
WCF50	20.80	71
WCF65	24.09	71
WCF75	25.49	71
WCF85	27.33	71
WCF90	27.98	71
WCFMULTICOR	31.44	71
WCM50	16.96	71
WCM75	17.99	71
WCMULTICOR	25.90	71
WCMULTICOR150	34.60	71
XAC115/165	63.82	34
XAC125/145	59.22	34
XAC125/160	60.18	34
XAC125/175	70.24	34
XAC125/190	73.26	34
XAC125/205	78.94	34
XAC140/160	68.90	34
XAC140/190	75.23	34
XAC140/230	99.42	34
XAC140/245	107.68	34
XAC160/185	74.76	34
XAC160/230	108.50	34
XAC160/245	114.74	34
XAC160/260	116.78	34
XAC160/280	140.44	34
XAC160/320	143.55	34
XAC175/195	79.50	34
XAC175/210	86.16	34
XAC190/230	110.95	34
XAC190/245	123.33	34
XAC190/260	121.44	34
XAC190/320	144.87	34
XAC400	28.59	34
XAC600	73.45	34
XAC800	127.74	34
XAC85/115	45.24	34
XAC900	139.75	34
XAC95/115	45.96	34
XBC105/05	7.96	38
XBC105/08	35.63	38
XBC115/05	8.64	38
XBC120/08	12.23	38
XBC125/05	8.80	38
XBC125/08	12.28	38
XBC125/16	21.34	38
XBC135/16	23.49	38
XBC140/08	14.00	38
XBC150/08	14.14	38
XBC150/16	25.37	38
XBC165/08	14.90	38
XBC168/16	28.53	38
XBC17/19	25.82	38
XBC175/16	28.43	38
XBC184/08	15.81	38

Code	Price £	Page
XBC185/24	39.39	38
XBC190/08	16.41	38
XBC200/16	30.58	38
XBC21/17	25.84	38
XBC210/24	41.57	38
XBC215/08	16.86	38
XBC225/16	31.30	38
XBC225/24	43.41	38
XBC230/16	32.14	38
XBC240/16	34.20	38
XBC245/08	17.96	38
XBC255/08	20.09	38
XBC26/14	25.82	38
XBC275/08	21.37	38
XBC37/09	23.73	38
XBC43/06	23.73	38
XBC65/23	44.54	38
XBC65/27	66.44	38
XBC76/17	40.49	38
XBC85/08	10.05	38
XBC90/08	11.06	38
XBC95/05	8.14	38
XBC95/08	36.53	38
XBC95/12	46.67	38
XDR115	27.55	35
XDR125	28.66	35
XDR135	30.34	35
XDR150	51.38	35
XDR165	51.45	35
XDR175	64.06	35
XDR180	64.72	35
XDR200	67.18	35
XDR215	72.00	35
XDR225	78.39	35
XDR250	92.74	35
XDR275	107.09	35
XDR65	26.65	35
XDR85	28.08	35
XDR95	28.32	35
XFD700	30.56	37
XFD800	30.56	37
XPA45/65	24.68	35
XPA50/115	31.32	35
XPA50/95	29.41	35
XPA65/115	35.75	35
XPA65/95	31.72	35
XSB115	73.50	36
XSB125	74.44	36
XSB135	75.05	36
XSB150	110.22	36
XSB165	113.79	36
XSB175	114.34	36
XSB180	115.04	36
XSB200	115.41	36
XSB215	122.46	36
XSB225	128.47	36
XSB250	134.48	36
XSB275	138.00	36
XSB290	140.08	36
XSB310	232.57	36

Code	Price £	Page
XSB320	239.67	36
XSB335	248.49	36
XSB345	253.08	36
XSB360	259.24	36
XSB385	265.82	36
XSB410	284.35	36
XST115	26.55	37
XST125	29.35	37
XST135	30.04	37
XST150	32.33	37
XST160	34.44	37
XST180	37.27	37
XST200	41.73	37
XST215	43.94	37
XST32	10.86	37
XST42	11.68	37
XST50	12.20	37
XST65	13.21	37
XST95	16.35	37
XTB800	30.56	37

# Guide to Ordering Procedures

## To help us improve our service level please ensure your orders:

- State clearly any Special Delivery Instructions, times, access, vehicle types.
- Product codes always override product descriptions.
- Product codes should be used when placing your order.
- Product pack & bag quantities should be observed and clearly stated as identified in this publication.
- When ordering products with colour options please use suffix detailed at top of page e.g. Grey (G).
- Carriage paid values detailed below should be considered.
- Complete promptly and return our Logistics fax (this is automatically sent to you when we create any new delivery points on your behalf).
- Any order alterations/cancellations will only be accepted up to the point when the load is compiled. It is not possible to effect changes after this.
- We will advise when orders fall short of the carriage paid terms and we have no other orders outstanding to which we can add to. We do not have facility on our system to process and hold low value orders.

# General Trading Information



## Pack Quantities

In order to provide our customers with shorter lead times we are looking for your support when placing orders.

Therefore to enable us to fulfil this, please place your orders in pack multiple quantities only.

We have carried out extensive research and reduced many of our pack quantities to satisfy the needs of today's market.

Products not ordered in pack multiples will be rounded up to the next saleable pack multiple.

## Stillage Deliveries

Extrusions are available in wooden frames for mechanical offload. Please refer to pack quantity list for detail. Mixed product frames are not available.

BAGS are only available in stillages by prior arrangement in pre-determined product/pack configuration. A charge will be levied on all metal stillages and refundable on return. A contract would be established to control and monitor stillage movements.

## Delivery Targets

- Merchants stock within a 7 working day period - not including day order was received.
- Building sites within a 5 working day period - not including day order was received.
- Other delivery requirements and emergency requests by prior arrangement.

## Site Deliveries

We will require logistical information before attempting to deliver to any new sites. Your prompt attention to these requests is important due to the short lead-time expectancy of end users.

## Emergency Collections Facility

We do have a pre-booked collection facility for emergency orders. A 48-hour notice period is required to comply with our health and safety policies.

## Carriage Paid Order Values

- Merchant Stock – £600.00 net
- Site Deliveries – £1100.00 net
- Site Deliveries MDPE – £1100.00 net

## Carrier

We can offer a 48-hour carrier facility to cater for your urgent requests. A scale charge will apply for this facility. Details are available on request. We do not offer an overnight service.

## Claims for Shortages & Damaged Extrusions (Pipes, Gutters and Large Mouldings)

Our drivers will countersign the delivery note as each of these products are offloaded.

## Bags

Each bag delivered will be identified with Customer name, load number, individual bag number and total bag count of your consignment.

The driver will offload and bag count. He will obtain your signature as confirmation that you have received the correct number of bags.

## Discrepancy Notification

All extrusions - i.e. pipes gutters and large mouldings are listed at the start of the advice note inventory. Any discrepancies in relation to Pipes, Gutters and Large Mouldings must be noted on the advice note at the time of delivery.

Bags - Any discrepancy relating to the number of bags delivered must be noted on the advice note at the time of delivery. Any discrepancies on bag contents must be advised within 7 days of delivery.

## Proof of Deliveries

Proof of delivery signatures for depot deliveries are available on 01709 770000 (ask for P.O.D.'s). All site deliveries will automatically be sent a P.O.D. via fax to the branch that placed the order.

## Return of Products

We do not accept return of any product surplus to requirement unless previously agreed in writing. Last minute customer cancellations may also be subject to a cancellation charge. Any agreed product returns would be subject to 25% re-stocking charge (£60 minimum).

## Terms and Conditions

A full copy of our terms and conditions are detailed overleaf.



# Terms & Conditions



## 1 GENERAL

- 1.1 In these conditions
- 1.1.1 "the Company" means Polypipe Building Products which is a registered trading division of Polypipe Limited. Company registration number 1099323, Registered office: Broomhouse Lane, Edlington, Doncaster DN12 1ES, United Kingdom.
- 1.1.2 "Customer" means the person with whom the Company contracts for the supply of Product pursuant to these conditions;
- 1.1.3 "Order" means any order submitted to the Company by a Customer;
- 1.1.4 "Order Confirmation" means any order confirmation submitted to the Customer by the Company;
- 1.1.5 "Product(s)" means the goods and/or services to be supplied by the Company as referred to and described in an Order which is accepted by the Company;
- 1.1.6 "Quotation" means the quotation submitted to the Customer by the Company prior to submission of an Order which details the prices at which the Customer may make an offer to purchase the Products;
- 1.1.7 "Writing" includes telex, cable, facsimile transmission, electronic data transfer and comparable means of communication.
- 1.2 A contract shall come into force between the Parties each time an Order is accepted by the Company, whether by issuing an Order Confirmation, by delivery, or otherwise, but not before. Subject to clause 1.3, (i) the terms of each contract shall be as set out in these conditions and the terms of any Order accepted by the Company, and (ii) in the event of any conflict between these conditions and any such Order, the terms of the Order shall prevail.
- 1.3 Save to the extent contemplated at clause 2.1, the parties agree that any terms and conditions submitted at any time by the Customer which have not been written specifically for the purposes of the Product requirement to which a specific Order relates (including, without limitation, any standard terms and conditions of purchase which are printed on any order documentation submitted by the Customer), shall not apply to any contractual dealings between the parties and shall not be deemed to constitute a counter-offer to purchase Products in accordance with those terms unless a specific intention is expressed for such terms and conditions to apply in respect of a specific Order notwithstanding this clause 1.3, and any failure by the Company to challenge or respond to any such terms and conditions does not imply and shall not constitute acceptance of those terms and conditions.
- 1.4 Unless otherwise stated therein Quotations shall be valid for a maximum period of 30 days from issue and may be withdrawn at any time by written or oral notice.
- 1.5 Any statement or representation (other than in the Company's Quotation or these terms and conditions) by the Company its servants or agents upon which the Customer wishes to rely must be set out in Writing and attached to or endorsed on the Customer's Order and in any such case the Company may confirm, reject or clarify the point and submit a new Quotation. Any statement or representation which is not so confirmed in Writing is followed or acted upon entirely at the Customer's own risk, and shall not form any part of the contract between the parties, and shall be deemed not to have influenced the Customer in deciding whether to enter into the contract.
- 1.6 The contract is between the Company and the Customer as principals; neither the benefit nor the burden is assignable by the Customer without the Company's written consent; the contract may be assigned or subcontracted by the Company.
- 1.7 Unless specifically agreed to the contrary all trade terms shall be interpreted in accordance with current INCOTERMS.
- 1.8 If, subsequent to any contract of sale which is subject to these conditions, a contract of sale is made with the same Customer without reference to any conditions of sale or purchase, such contract howsoever made shall be deemed to be subject to these conditions or (if different) the standard Conditions of Sale of the Company current at the time when such contract of sale is made.
- 2 ELECTRONIC TRADING
- 2.1 If the Company and Customer agree that electronic trading between them shall be a basis for order processing and invoicing then these terms and conditions shall apply subject to any special terms and conditions terms which are specific to electronic trading and which have been agreed by the parties in writing.
- 2.2 Electronic orders shall be valid if all the information agreed between the Customer and the Company as being required is properly set out in the agreed format and the order is transmitted by the Customer to the Company by reference to the correct identification code and is received by the Company when collecting its electronic mail from the relevant system.

## 3 DELIVERY

- 3.1 Unless otherwise agreed in Writing by the Company delivery shall be deemed to take place in the case of ex-works sales when the Products are made available by the Company for collection by the Customer or its carrier and in all other cases upon delivery by the Company to the agreed mainland UK delivery point airport or port but before the Products are unloaded, which shall be the responsibility of the Customer.
- 3.2 The Company shall not be obliged to make delivery unless and until the Company has received all necessary information, drawings, final instructions and approvals from the Customer and the Customer acknowledges that any delays or alterations by the Customer may result in delayed delivery for which the Company shall not be responsible.
- 3.3 All dates and periods for delivery are estimated and do not constitute fixed times for delivery by the Company. Unless such a right or rights are expressly agreed in Writing by the Company, the Customer shall have no right to damages or to cancel the contract for failure arising from any cause to meet any delivery times given in the contract or subsequently set.
- 3.4 Notwithstanding clause 3.3 the Customer shall be obliged to accept delivery on the date or within the period stated in the Quotation or (if none is so stated) no later than one month after the issue or notice in Writing by the Company requiring the Customer to accept delivery. Failure by the Customer either to take delivery or to make payment in respect of any one or more installments of Products shall entitle the Company to terminate the Contract (such right is without prejudice to any other rights and remedies available to the Company whether expressly provided for in these Conditions or implied by any rule of law).
- 3.5 Where the Customer requests and the Company agrees to postpone delivery or where delivery is otherwise postponed or delayed without default by the Company, the Customer shall pay upon receipt of written demand from the Company all costs and expenses including a reasonable charge for storage and transportation occasioned thereby and the Customer shall pay for the Products in accordance with these conditions as if the same had been delivered in the ordinary course without reference to the postponement or delay. In addition, the Company shall be entitled to claim interest pursuant to Clause 7.3.2 of these Conditions from the date on which payment would have fallen due, had the Products been delivered in the ordinary course but for the postponement or delay.
- 3.6 Unless otherwise expressly agreed in Writing the Company may effect delivery in one or more installments. Where delivery is effected by installments each installment shall be treated as a separate contract governed by these conditions. No delay in the delivery of any installment of Products or any defect therein shall entitle the Customer to terminate the remainder of the contract.

## 4 RISK AND TITLE

- 4.1 Risk of damage to or loss of the Products shall pass to the Customer upon delivery and the Customer is then solely responsible for all loss damage or deterioration to the Products.
- 4.2 Title to the Products shall not pass to the Customer until either:-
  - 4.2.1 The Company has received in cash or cleared funds all monies payable (whether or not due) to the Company under this and any other contracts whenever made between the Company and the Customer including contracts made after this contract; or
  - 4.2.2 When the Company serves on the Customer notice in Writing specifying that title in the Products or any part thereof has passed.
- 4.3 Until title has passed to the Customer the Company may require the Customer to deliver up to the Company all products in respect of which the Company has title and if the Customer fails to do so forthwith the Company's officers, employees, representatives or agents shall be entitled to enter upon any premises where such Products are kept for the purposes of recovering the same.
- 4.4 Until title to the Products has passed to the Customer pursuant to these conditions it shall possess the Products as fiduciary agent and bailee of the Company and shall store the Products separately from other goods not owned by the Company and shall ensure that they are fully insured on an all risks basis and clearly identifiable as belonging to the Company and the Company shall be entitled to enter upon any premises where such Products are kept for the purpose of satisfying itself that this condition is being complied with by the Customer.
- 4.5 In the event that the Customer has any contract with any other company under the ultimate control of the parent company that has ultimate control of the Company under which any monies are outstanding (whether or not due) then the Customer shall not (notwithstanding that title would otherwise pass pursuant to Clause 4.2 above) obtain title to the Products or other goods supplied by the Company under this or any other contracts between them until such other company has received in cash or cleared funds all such monies.

# Terms & Conditions



## 5 CANCELLATION AND AMENDMENT

5.1 No contract can be amended or cancelled except with the Company's approval in Writing and should such approval be given the Customer shall indemnify the Company against any costs, losses or expenses resulting from any cancellation or amendment.

## 6 PRICES

6.1 Unless otherwise agreed in Writing all prices shall be as stated in the valid Quotation or, if no valid Quotation is in place, the Company's prevailing standard price at the time of receipt of an Order, and are for delivery ex works and are exclusive of VAT and any other applicable taxes, which are payable in addition. Unless otherwise stipulated by the Company in Writing prices are payable in Sterling or if the Sterling currency has ceased to exist when the contract is made, shall be payable in such currency as replaces the Sterling currency.

6.2 The Company will use its best endeavors to ensure that all prices on display/provided to Customers are correct and up to date. However, should a Customer place an Order using an incorrect price then the Customer agrees that the Company may substitute the incorrect price set out in the Order for the correct price (whether the price specified on a valid Quotation or the Company's prevailing standard price, as appropriate) and charge accordingly.

6.3 The Company shall be entitled at any time by giving notice in Writing, before or after final invoicing to make a reasonable adjustment to the price in the event of any alteration in quantity, design or specification requested by the Customer.

6.4 The Company reserves the right at any time prior to delivery by giving notice in Writing to increase the price if there is any increase in the cost of materials, labour, transport, or utilities or if the costs of the Company are increased by any other factor beyond the reasonable control of the Company.

6.5 Charges made on the Company's invoice for cases will be credited on their return to the Company's premises carriage paid and in good reusable condition. Cases shown as returnable but not charged on the Company's invoice must be returned to the Company's premises carriage paid and in good re-usable condition otherwise an additional charge will be made in respect of their cost.

6.6 The Customer shall be liable to the Company for any demurrage costs incurred in the event of vehicles being unduly delayed at the point of delivery.

## 7 TERMS OF PAYMENT

7.1 Unless otherwise agreed by the Company in Writing, the Customer shall make payment by the last day of the month following the month of invoice and the Company shall be entitled to issue invoices in the month in which the Products are delivered or would have been delivered, save for postponement or delay otherwise than due to default on the part of the Company. Time for payment of the price is of the essence of the contract.

7.2 No disputes arising under this contract shall serve to permit payment by the Customer of sums due to the Company to be delayed nor shall disputes interfere with prompt payment in full. The Buyer shall not be entitled to make any deduction from or set off against any sums owing to the Company by reason of any such dispute or at all.

7.3 In the event of default in payment by the Customer the Company shall be entitled, without prejudice to any other right or remedy:

7.3.1 to suspend without notice all further deliveries on this or any other contract between the Company and the Customer;

7.3.2 to charge interest on a daily basis (after as well as before judgement) on any amount outstanding at the rate of 4% above the Base Rate of Lloyds Bank plc from time to time; and/or

7.3.3 to serve notice on the Customer requiring immediate payment for all goods supplied by the company under this and all other contracts between them whether or not payment is otherwise due or invoiced.

## 8 SPECIFICATIONS

8.1 Subject to Clause 8.2 the Products shall in all material respects be of such specification agreed between the Company and the Customer under the contract, or (if not so agreed) shall be generally in all materials respects in accordance with any published specification issued by the Company.

8.2 The Company reserves the right to make changes in dimensions or other specifications of the Products as are required to conform to applicable standards or laws or are otherwise within reasonable limits having regard to the nature of the Products. Dimensions specified by the Company are to be treated as approximate only unless it is specifically agreed in Writing that exact measurements are required.

8.3 The Customer acknowledges that it has not specified any particular use for the Products and that it is entirely its own responsibility to satisfy itself that the Product is suitable for the use which it intends.

## 9 LOSS SHORTAGES AND DAMAGE APPARENT ON DELIVERY INSPECTIONS

9.1 The Customer shall have no claim for loss, shortages or damage on delivery which are or would be apparent on inspection unless the Customer:

9.1.1 unpacks and inspects the Products as soon as reasonably practicable following receipt;

9.1.2 notifies the Company of any loss, shortages or damage (otherwise than by a qualified signature on the delivery note) within ten working days of receipt; and

9.1.3 demonstrates to the satisfaction of the Company that such loss, shortages or damage occurred prior to delivery.

9.2 The Customer shall have no rights in respect of loss, shortages or damage unless the Company is given a reasonable opportunity to inspect the Products and investigate any complaint before any use of or alteration to or interference with the Products.

9.3 On a valid complaint made in accordance with this Clause the Customer shall be entitled (in the case of notified shortages) to receive within a reasonable time a delivery of Products equivalent to the shortfall and (in the case of defects) to repairs to or replacements for the affected Products or at the Company's option a credit for the price thereof but the Company shall have no further liability whatsoever. If a complaint of loss, shortages or damage on delivery is not made to the Company in accordance with this Clause 9 within 5 working days of the date of delivery, then the Products shall be deemed to be delivered complete and undamaged in accordance with the contract and the Customer shall be bound to pay for the same accordingly.

9.4 Loss, shortages or damage in a delivery or any installment delivery shall not be a ground for termination of the contract or the remainder of the contract (as the case may be).

## 10 WARRANTY

10.1 The Company warrants that Products which do not comply with either Clause 8.1 or Sections 13 to 15 of the Sale of Goods Act 1979 (as amended) are shown to have been defective at delivery as a result of faulty design workmanship or materials (other than free-issue materials), shall either be repaired or replaced or that, at the Company's option, a credit or refund for the price thereof shall be given provided always that:

10.1.1 the Company receives written notice of the defect within 12 months of delivery;

10.1.2 no alteration to or interference with the Products takes place before the Company is given access to the Products to inspect and test the same;

10.1.3 the defect does not consist of a loss shortage or damage to which Clause 9 is expressed to apply;

10.1.4 the defect does not arise by reason of a design specification or instruction given by the Customer;

10.1.5 the Customer has not defaulted in its obligation to make payment of the contract price for the Products;

10.1.6 the defect shall not be attributable to incorrect storage or use of the Products by the Customer.

10.2 The benefit of Clause 10.1 shall only extend to Products or parts not manufactured by the Company to the extent that the Company has equivalent recourse against the manufacturer or supplier thereof.

10.3 The Customer shall indemnify the Company in respect of loss or damage arising from any use made of Products after the Customer became or ought reasonably to have been aware of a defect.

10.4 In the event of a valid claim being made in accordance with Clause 10.1:

10.4.1 the Customer shall be bound to accept repaired or replacement Products or at the Company's option credit or repayment and shall not be entitled to terminate the contract;

10.4.2 if the Company does not repair or replace Products within 60 days or such longer time as may be reasonable then the Customer's sole remedy shall be an entitlement to full credit or repayment in respect of the defective Products; and the Company shall be under no further liability in respect of any loss or damage arising from the defect or from any delay before repair replacement credit or refund is effected.

## 11 LIABILITY

11.1 The Company does not exclude liability arising under Section 12 of the Sale of Goods Act 1979 (good title) (as amended) or for death or personal injury caused by its negligence as defined in the Unfair Contract Terms Act 1977, fraudulent misrepresentation or any other type of liability which cannot by law be excluded or limited

# Terms & Conditions



- 11.2 Save as provided under Clauses 9, 10 and 11.1 the Company shall have no liability to the Customer in connection with or arising from any defect or failure in the Products or otherwise due to the quality, condition, suitability, durability, safety or any other aspect or feature of the Products. The Company's liability, whether in respect of one claim or in the aggregate, shall not exceed the contract price payable under this contract for the supply of Products to be provided under it. The price of the Products is predicated on the basis of the limitations and exclusions set out in these conditions. The Customer acknowledges that without those exclusions and limitations, the price of the Products would be higher and that the limitation of the Company's liability is therefore reasonable in all the circumstances. The Customer agrees that it is its own responsibility to insure adequately to cover any loss or damage in excess of the aforesaid limit of the Company's liability. Subject to reaching agreement on terms, the Company and the Customer may determine an increased level of liability which is to be accepted in Writing by the Company to cover, in particular specific types of loss or damage which both parties reasonably foresee and anticipate.
- 11.3 In Clause 11.2 the term "liability" means any form of liability whatsoever including but not limited to liability in misrepresentation and under contract, common law, equity and any statutory provision whether or not based on negligence or breach of any express or implied duty to act with care or skill.
- 11.4 Notwithstanding any other provisions of these conditions the Customer shall have no claim against the Company in respect of any loss other than strictly direct losses (meaning for these purposes the increased costs of purchasing products from a third party or the cost of remedial repair work) and specifically consequential, financial economic loss whether direct or indirect including but not limited to any incidental costs of dismantling fitting or other ancillary work required in connection with the provision of a repair or replacement, any loss or production profits contracts loss of use or anticipated savings and any claims made against the Customer by any third party are excluded even if reasonably foreseeable.
- 11.5 To the extent that any liability of the Company is expressed to be limited or excluded by these conditions the Customer shall indemnify the Company in respect thereof.
- 12 CONFIDENTIAL INFORMATION ETC**
- 12.1 All drawings, documents, records, computer software and other information supplied by the Company are supplied on the express understanding that all intellectual property rights therein is reserved to the Company and that the Customer will not without written consent of the Company either give away, loan, exhibit, or sell the same or extracts therefrom or copies thereof or use the same in any way except in connection with the Products in respect of which they are issued.
- 13 PATENT INDEMNITIES**
- 13.1 If the Customer is subject to a claim or threatened with any action alleging that the Products in the form supplied infringe any patent, copyright, design right or other intellectual property right then provided that the Customer promptly informs and fully co-operates with the Company and if requested allows the Company the conduct and defence thereof on the Customer's behalf, the Company will indemnify the Customer against any award or damages for infringement made in any such action by a court or other competent body against the Customer. Further, if the Products are infringing the Customer agrees that the company shall have the option at its own expense either to modify the Products so that they do not infringe; to replace the Products with a non infringing substitute; to procure for the Customer the right for the Customer to continue its use of the Products; or to repurchase the Products from the Customer at the price paid by the Customer less an allowance for the use made thereof.
- 13.2 The Company shall have no liability in respect of claims for infringement or alleged infringement of third parties patent or other intellectual property rights arising from the manufacture or supply of the Products to the Customer's instructions or in accordance with designs plans or specifications given by the Customer and the Customer shall indemnify the Company against all losses damages expenses costs or other liability arising from such claims.
- 14 CUSTOMER'S DRAWINGS**
- 14.1 The Customer shall be solely responsible for ensuring that all drawings information advice and recommendations specified or given to the Company by the Customer or its agents, servants consultants or advisers are accurate correct and suitable Examination or consideration by the Company of such drawings information advice or recommendations shall not result in any liability on the part of the Company.
- 15 COMPANY LITERATURE**
- 15.1 The information contained in the advertising, sales, technical, and other literature issued by the Company may be relied upon to be accurate in the exact circumstances in which it is expressed otherwise any illustrations performance details examples of installations and methods of assembly and all other information and data in such literature are based on experience and upon trials under test conditions and are provided for general guidance only. No such information or data shall form part of the contract unless it is specifically referred to in the Quotation.
- 16 TERMINATION**
- 16.1 Without prejudice to any other rights or remedies of the Company it shall be entitled in any of the following circumstances to terminate (in whole or in part) this and any other contract whenever made between the Company and the Customer and/or to suspend deliveries and/or to receive upon demand payment of all monies payable under any such contracts whether or not otherwise due:
- 16.1.1 The Customer made or proposes any voluntary arrangement with its creditors or becomes subject to an administration order or becomes bankrupt or goes into liquidation;
- 16.1.2 an encumbrancer takes possession or a receiver is appointed of any of the property or assets of the Customer;
- 16.1.3 The Customer becomes unable to satisfy its debts as they fall due or cease, or threatens to cease to carry on business;
- 16.1.4 The Company reasonably believes that any of the events mentioned above or any equivalent or similar event under any relevant laws to which the Customer or any connected person is subject has or may occur;
- 16.1.5 the Customer or any connected person commits any breach of this or any other contract whenever made between the Customer and the Company.
- 17 FORCE MAJEURE**
- 17.1 The Company shall be excused performance of its obligations whilst and if affected by act of God governmental restriction condition or control, any act done or not done pursuant to a trade dispute whether such dispute involves its employees or not, default by suppliers of the Company, shortage of materials or by any other act matter or thing beyond its reasonable control including failure by the other party to carry out anything required for performance of the contract.
- 17.2 In the event that the Company does not perform its obligations by reason of any of the causes referred to in Clause 17.1 within six months after the time for performance then the Company or the Customer may by written notice terminate the contract without liability save that the Customer shall pay for any Products delivered or completed at the time of termination.
- 18 TOOLS**
- 18.1 Any tools (such as jigs, dies, etc) which the Company may construct or acquire specifically in connection with the Products shall, notwithstanding any charges the Company may make for them, be and remain the Company's sole and unencumbered property and in the Company's possession and control without restriction.
- 19 FREE-ISSUE MATERIALS**
- 19.1 Free-issue material shall be insured by and remain at the risk of the Customer at all times and the Company shall be indemnified by the Customer against any loss, damage, injury or expense whatsoever arising directly or indirectly therefrom and the company shall not be liable for loss of or damage to any such materials during fabrication by the Company or sub-contractor employed by Company or whilst on the premises of the Company or of any such sub-contractor or in transit to or from the Company may at its sole discretion make a contribution towards the replacement costs of such materials.
- 19.2 An allowance for material lost as process scrap is (where applicable) included in the contract price and no such losses shall be the subject of any claim by the Customer or contribution by the Company.
- 19.3 Where materials are supplied by or on behalf of the Company the Customer shall be responsible to ensure that the material is of satisfactory quality and is fit for its purpose and shall indemnify be Company against any loss damage, injury or expenses whatsoever arising directly or indirectly from any fault in or incorrect specification of the said materials.

# Terms & Conditions



## 20 CONSUMER PROTECTION ACT 1987

- 20.1 Where the Customer purchases the Products for use or incorporation with any other products to be assembled, produced, processed packed or supplied by the Customer or for resale or supply ancillary to any such other products or other products supplied by the Customer then:
- 20.1.1 the Customer shall forthwith on demand produce for inspection by the Company copies of all written instructions information and warnings to be supplied by the Customer in relation thereto provided nevertheless that such inspection or right to inspect shall not give rise to any responsibility or liability on the part of the Company; and
- 20.1.2 the Customer shall indemnify the Company against any losses, costs and damages that the Company may suffer or incur in the event any claim is made against the Company in relation thereto if the Products did not comprise the defective element thereof or were rendered defective by reason of actions or omissions of the Customer (including without limitation the supply of defective free-issue materials) or were rendered defective by reason of instructions or warnings given or omitted by the Customer or other reseller.
- 20.2 For the purpose of Clause 20.1 the term "defective" shall be interpreted in accordance with the definition contained in Part 1 of the Consumer Protection Act 1987.

## 21 HEALTH & SAFETY

- 21.1 The Customer agrees to pay due regard to any information supplied by the Company relating to the use for which the Products are designed or have been tested or concerning conditions necessary to ensure that they will be safe and without risk to health at all times when they are being set, used, cleaned, serviced or maintained by any person and the Customer undertakes to take such steps as may be specified by such information or otherwise necessary to ensure that as far as is reasonably practicable the Products will be safe and without risk to health at all times as mentioned above.

## 22 LAW AND JURISDICTION ETC

- 22.1 The Contract shall be governed and interpreted exclusively according to the Laws of England.  
The parties hereby agree to submit to the exclusive jurisdiction of the English courts provided that the Company may at its option take proceedings in the courts of the state in which the Customer is domiciled including action to obtain any remedy (including injunctive relief). In the case of any order for the export of Products, the Schedule to the Uniform Law on International Sales Act 1967 shall not in any circumstances apply to the Contract and neither shall the limits imposed by the Unfair Contract Terms Act 1977 on the extent to which liability can be excluded or limited.
- 22.2 No waiver of or delay or failure by the Company to exercise any rights or remedies shall prejudice or preclude any future or further exercise thereof.
- 22.3 If any provision of these conditions shall be held invalid or unenforceable in whole or in part then the unaffected provisions shall remain in full force and effect. Headings appear for convenience only and shall not affect the Construction of these conditions.
- 22.4 If the Contract provides for the supply of services and no general conditions of the Company relating specifically to the supply of services are made applicable to such services then these conditions shall mutatis mutandis apply to such services as they would apply to Products and in such event Clause 10.1 will be deemed to include a reference to Sections 3 to 5 of the Supply of Goods and Services Act 1982 (as amended), either in addition to or in place of the reference to Sections 13 to 15 of the Sale of Goods Act 1979 (as amended) as may be appropriate. For the avoidance of doubt the following provisions apply where the Company supplies services to the Customer in accordance with clause 22.4:-
- 22.4.1 the Company's obligation to provide the services is in any event conditional upon payment of the agreed price for the services. Any default or delay in payment according to the terms agreed between the Company and the Customer shall entitle the Company at its option to decline to perform or decline to continue to perform its obligations hereunder but without thereby incurring any liability to the Customer.
- 22.4.2 Save to the extent that by reason of negligence on the part of the Company in the performance of the services which results in death or personal injury (which the Company does not limit or exclude), the Company's liability under the contract shall be limited to the amount of charges paid to the Company in return for the services and in particular the Company accepts responsibility only for direct and unavoidable loss or damage arising from any negligence in the provision of services and in particular all other types of loss whether economic, financial, indirect or consequential and whether reasonably foreseeable or not are excluded to the fullest extent permitted by law.

- 22.4.3 The Customer shall lend all such reasonable assistance to the Company in the performance of the services as the Company shall reasonably require.
- 22.4.4 The Customer shall indemnify and keep the Company, its employees, agents and Contractors indemnified at all times from and against any loss or damage and injury caused to persons or property in the course of the provision of the services where such loss or damage arises by reason of the Customer's negligence or negligence of persons under the control of the Customer.
- 22.4.5 The Customer acknowledges and agrees that if due to the act or omission of the Customer, the Company is not able, having attended at the Customer's premises to perform the services, the Company shall be entitled to claim reasonable additional costs and expenses from the Customer occasioned by any resulting delay in the provisions of the services.
- 22.5 In cases for the sale or supply of Products overseas, the following additional provisions shall apply unless otherwise stipulated in writing by the Company:
- 22.5.1 the Customer shall be solely responsible for obtaining all necessary import authorisations, the payment of any applicable import taxes, duties or imposts and the Company shall be under no obligation to give the Customer the notice specified in Section 32(3) of the Sale of Goods Act 1979 (or any re-enactment thereof);
- 22.5.2 Quotations issued in a currency other than Sterling may at the Company's option, unless otherwise agreed in writing, be subject to amendment in the event of fluctuations in the applicable exchange rate prior to the date of invoice;
- 22.5.3 payment in respect of Products for export is due on the date specified by the Company at the date when the Contract is made, in the currency stated in the invoice and in accordance with the method of payment stipulated by the Company. All costs incurred by the Company in connection with the designated particular method of payment shall be met by the customer.
- 23 DISTANCE SELLING REGULATIONS
- If you are a consumer within the meaning of the Distance Selling Regulations 2000 and you have bought the products detailed overleaf over telephone, internet or via mail order then within seven days of receipt of your products you have the right to cancel your order and return the Products for a full refund.







# Below Ground Drainage, Water Supply, Utilities & Insulation Trade Price List 2019



## **Polypipe Ulster**

Dromore Road, Lurgan Craigavon, Co. Armagh, BT66 7HL, UK

T: +44 28 38 881270 F: +44 28 38 882344

## **Polypipe Building Products**

2410 London Road, Mount Vernon, Glasgow, G32 8XZ, UK

T: +44 141 778 8822 F: +44 141 778 2703

## **Polypipe Building Products**

Broomhouse Lane, Edlington, Doncaster, DN12 1ES, UK

T: +44 1709 770000 F: +44 1709 770001